



FM4000
RF Transmitter Package

User's Manual

©2005 Crown Broadcast, a division of International Radio and Electronics, Inc.
25166 Leer Drive, Elkhart, Indiana, 46514-5425 U.S.A.
(574) 262-8900

Revision Control

Revision

Print Date

Initial Release (Rev. 1)

September 2005

Important Notices

©2005, Crown Broadcast, a division of International Radio and Electronics, Inc.

All rights reserved. No part of this publication may be reproduced, transmitted, transcribed, stored in a retrieval system, or translated into any language in any form by any means without the written permission of Crown International, Inc.

Printed in U.S.A.

Crown attempts to provide information that is accurate, complete, and useful. Should you find inadequacies in the text, please send your comments to the following address:

International Radio and Electronics
25166 Leer Drive, P.O. Box 2000
Elkhart, Indiana, 46515-2000 U.S.A.

Contents

Section 1—Getting Acquainted

1.1 Your Amplifier Package	1-2
1.2 Amplifier Package Specifications	1-3
1.3 Safety Considerations	1-4
1.3.1 Dangers	1-4
1.3.2 Warnings	1-4
1.3.3 Cautions	1-4

Section 2—Installation

2.1 Operating Environment	2-2
2.2 Tools Required	2-2
2.3 Unpacking	2-2
2.4 Preinstallation	2-3
2.4.1 Power Amplifier Modules	2-3
2.4.2 Hubble Twist Lock® Connector Wiring	2-4
2.5 Installation	2-8
2.6 Remote I/O Connection	2-9

Section 3—Operation

3.1 Initial Power-up Procedures	3-2
3.2 Power Switches	3-4
3.2.1 AC Input Circuit Breaker	3-4
3.2.2 DC Power Switch	3-5
3.2.3 Interlock Switch	3-5
3.3 Digital Multimeter	3-6
3.4 Fault Indicators	3-7
3.5 Fuse Indicators	3-8

Section 4—Reference Drawings

4.1 Views	4-2
4.2 Block Diagram	4-3
4.3 Transmitter Controller Board Component ID.....	4-4
4.4 Transmitter Controller Board Schematic.....	4-5

Section 5—Service and Support

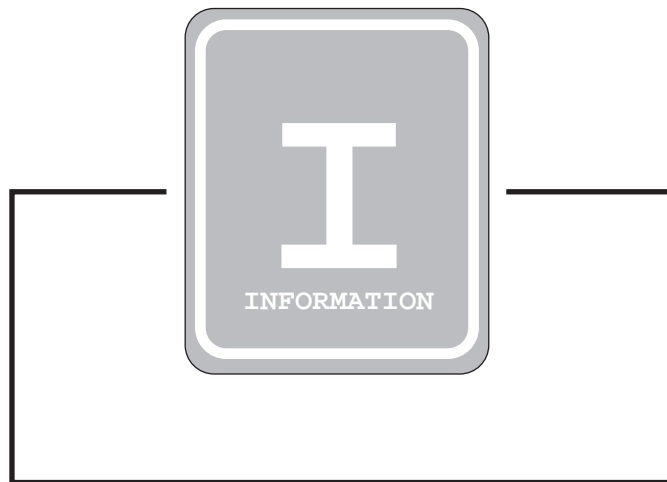
5.1 Service.....	5-2
5.2 24-Hour Support.....	5-2
5.3 Spare Parts.....	5-2

Glossary

Index

Glossary

Index



Section 1—Getting Acquainted

This section provides a general description of the FM4000 transmitter system and introduces you to safety conventions used within this document. *Review this material before installing or operating the system.*



1.1 Your Transmitter Package

The FM4000 is a highly efficient transmitter package designed to set a new standard in FM transmitter design offering modularity, ease of use, and long-term reliability. The FM4000 package includes two (2) PA2000 amplifiers, two (2) PS2000 power supplies, a combiner with coupler, a transmitter controller, and all necessary cabling.

The PA4000 transmitter package requires no tuning and typically provides 75% RF efficiency across the band. The PS2000 power supplies are power factor corrected and 90% efficient. Modern MOSFET technology ensures high AC to RF efficiency (better than 70% overall) and long-term reliability. The unmatched efficiency of this transmitter significantly improves your bottom line by providing cooler operation and lower power costs.

These modular units are uniquely designed to be lightweight and compact for convenient shipping, and require only fourteen RU spaces for installation. Installation is made simple with just three interconnections between each amplifier and power supply. In addition, built-in digital metering and status indicator capabilities enable intuitive operation to further augment the user-friendly design.

Economic long-term reliability is ensured through our carefully engineered solid-state design. Each PA2000 features four field-replaceable 500-watt power modules.

This transmitter delivers 400 to over 4000 watts of RF power output. Use your existing exciter or purchase the FM4000T which includes our award-winning FM250 exciter for an unbeatable 4 kW transmitter package.

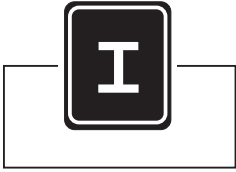


Illustration 1-1 FM4000 Transmitter Package

1.2 Transmitter Package Specifications

RF Power Output:	400 to 4400 watts continuous with remote controlled power adjust
RF Drive Requirement:	140 watts for full output
RF Output Impedance:	50 ohms (unbalanced)
Maximum SWR:	1.7:1 (With power foldback at high SWR)
Frequency Range:	87–108 MHz
RF Harmonics/Spurious Products:	Better than –80 dB
Asynchronous AM S/N Ratio:	Better than –55 dB with 100% modulation at 400 Hz, no de-emphasis, no FM modulation (typically > 60 dB)
Synchronous AM S/N Ratio:	Better than –55 dB with 100% modulation at 400 Hz, no de-emphasis, FM modulation=75 kHz @400 Hz (typically > 60 dB)
Operating Environment:	
Temperature Range:	0°–50°C at sea level
Humidity Range:	0–80% at 20°C (noncondensing)
AC Power:	240 Volts AC +10/-15%, 50–60 Hz; (120 Volts AC for driver)
Power Consumption:	Less than 5600 watts at 4400 watts RF output typical
Power Factor:	.96 typical
Overall Efficiency:	70% typical
RF Output Connector:	7/8 in. EIA flange, 7–16 in DIN optional
Power Amplifier Chassis:	7 x 17.25 x 23 inches (17.78 x 43.82 x 58.42 cm) exclusive of rack ears, but inclusive of connectors
Power Supply Chassis:	5.25 x 17.25 x 23 inches (13.34 x 43.82 x 58.42 cm) exclusive of rack ears
Weight:	PA2000—40 pounds (18.1 kg) RF PA Modules—8 pounds (3.6 kg) each PS2000—43 pounds (19.5 kg)

Note: System performance is specified using Crown Broadcast Model FM250 Exciter where applicable.



1.3 Safety Considerations

Crown Broadcast assumes the responsibility for providing you a safe product and safety guidelines during its use. “Safety” means protection to all individuals who install, operate, and service the transmitter as well as protection of the transmitter itself. To promote safety, we use standard hazard alert labeling on the product and in this manual. Follow the associated guidelines to avoid potential hazard.

1.3.1 Dangers

DANGER represents the most severe hazard alert. Extreme bodily harm or death will occur if **DANGER** guidelines are not followed.

1.3.2 Warnings

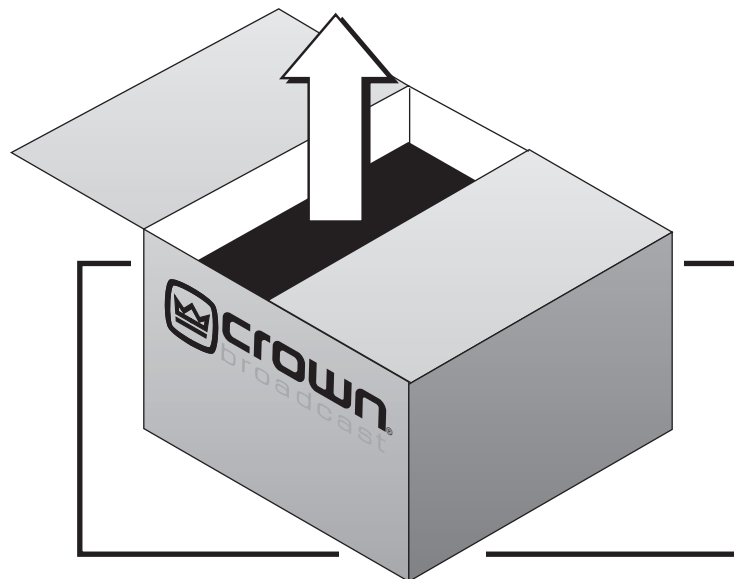
WARNING represents hazards which could result in severe injury or death.

1.3.3 Cautions

CAUTION indicates potential personal injury or equipment or property damage if the associated guidelines are not followed. Particular cautions in this text also indicate unauthorized radio-frequency operation.

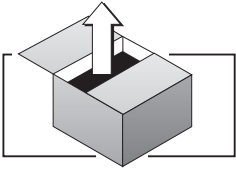


Illustration 1–3 Sample Hazard Alert



Section 2—Installation

This section provides important guidelines for installing your transmitter. Review this information carefully for proper installation.



2.1 Operating Environment

You can install the FM4000 transmitter in a standard 19-inch component rack or a cabinet or our own pre-wired cabinet on any flat surface. In any case, the area should be as clean and well-ventilated as possible. The power supply must be installed directly below the power amplifier (for the included dressed cables to reach their respective connectors).

2.2 Tools Required

To install the power supply and power amplifier, you will need the following tools:

- Medium phillips screwdriver
- Medium flat-blade screwdriver
- Small flat-blade screwdriver
- 7/16-Inch wrench or nut driver
- ESD (Electrostatic Discharge) protection grounding strap and/or mat.

2.3 Unpacking

Before handling any exposed printed circuit boards, ground yourself with an antistatic strap and/or mat.



The power amplifiers, power supplies, and eight power amplifier modules are packed and shipped in individual boxes because of their modular nature. *If you have purchased a pre-wired cabinet, you may disregard the next section and proceed to step 2.5.* For added protection, both of the PA2000 amplifiers and PS2000 supplies are packed in an inner box and then placed inside an outer box with styrofoam protective corners in both boxes. You will need to unpack a total of eight boxes (plus two inner boxes).

Note: Save the boxes and packaging material that the individual units are packed in should you need to return them for factory service.



2.4 Pre-installation

2.4.1 Power Amplifier Modules

If you have ordered a cabinet system, proceed to step 2.5. Each PA2000 incorporates eight power amplifiers (two each in four modules). Due to possible damage during shipment, the modules have been removed. Follow these steps to install the modules:

1. Remove each front panel of each PA2000 (four screws).
2. Taking ESD precautions (see page 2-2), unpack the power modules and place them on your work area with the circuit sides up.



Illustration 2-1 Power Amplifier Module

3. The warning labels on the front of the modules should all be positioned to the center of the chassis, also note the position of the connector on the modules and in the chassis.
4. Insert the eight power modules, using their slide rails, into the built in channels of the right and left side cavities as shown below. Note that the connectors and warning labels are nearest the middle wall or partition of each PA2000.

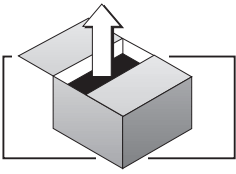


Before installation

After installation

Illustration 2-2 Power Amplifier Module Placement

5. Be sure the modules are pushed in completely so that the connector makes proper contact.
6. Replace each front panel of each PA2000.



2.4.2 Hubble Twist Lock® Connector Wiring

Prepare the wiring for the Hubble Twist-Lock® connector in the following manner before connecting to your AC power source:

1. Use round cord with a diameter of 0.385–0.780 inches (10–20 mm), Type SJ 12/3 – 10/3; Type S 16/3 – 10/3.
2. Select conductor size from your National Electrical Code®.
3. Slide the cover onto the cord. Remove insulation from cable and conductors as shown in Illustration 2–3. Do not tin conductors.

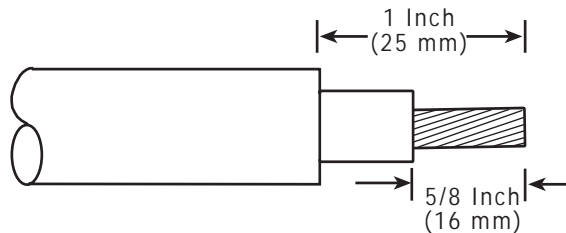


Illustration 2–3 Cover, Cable & Conductors

4. Loosen terminal screws. Insert conductors fully into proper terminals according to the table below. Take caution that there are no stray wire strands.

Terminal	Conductor
Green Hex Head Screw	Equipment grounding conductor (green or green/yellow)
Brass Screw	Hot circuit conductor, 240 VAC (NOT white, NOT green)
Brass/Black Screw	Hot circuit conductor, 240 VAC (NOT white, NOT green)

5. Tighten terminal screws to 18 pound•inches (2.1 N•m) of torque.
6. Tighten assembly screws to 10 pound•inches (1.1 N•m) of torque.
7. Tighten cord clamp screws to 10 pound•inches (1.1 N•m) of torque.

⚠ WARNING

Possible Electric *Shock* Hazard!

Do not connect AC source until all other connections are made and installation is complete.

2.4.3 System Wiring

Refer to page 4-3 Section 4.2 Block diagram when connecting together the different components of the FM4000 system.

1) Mount each of the components of the FM4000 system in an appropriate 19" rack as shown in illustration 2-6.

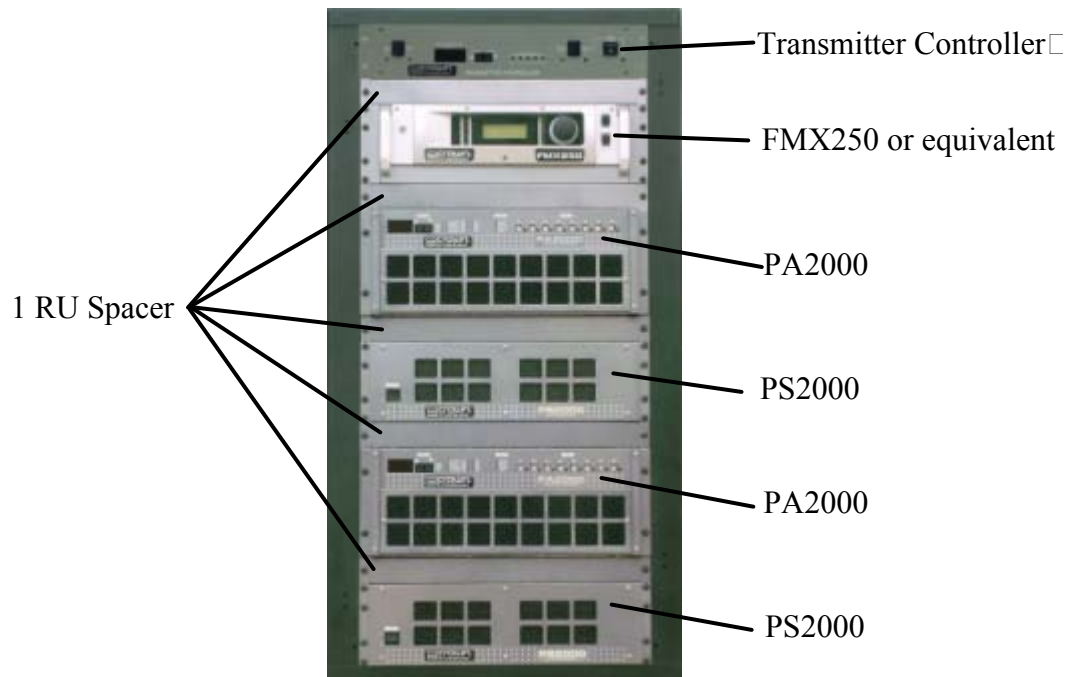


Illustration 2-6 FM4000 Rack definition

2) Locate the DB-9 Male-to-Male cable and connect between 'Control' on both the PA and PS. The 'Control' point for each is shown in Illustration 2-7.

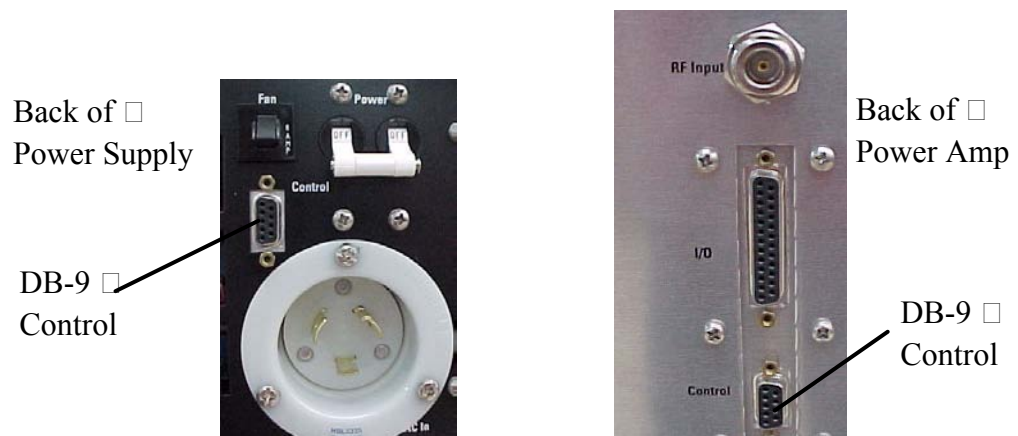


Illustration 2-7 Control point locations

3) Locate the DB-25 Male-to-Male cables and connect between 'I/O' port on □ both of the PA's and the ports labled PA1 and PA2 on the Transmitter □ Controller with the top PA going to PA1. The I/O ports and PA input ports □ for each is shown in Illustration 2-8.

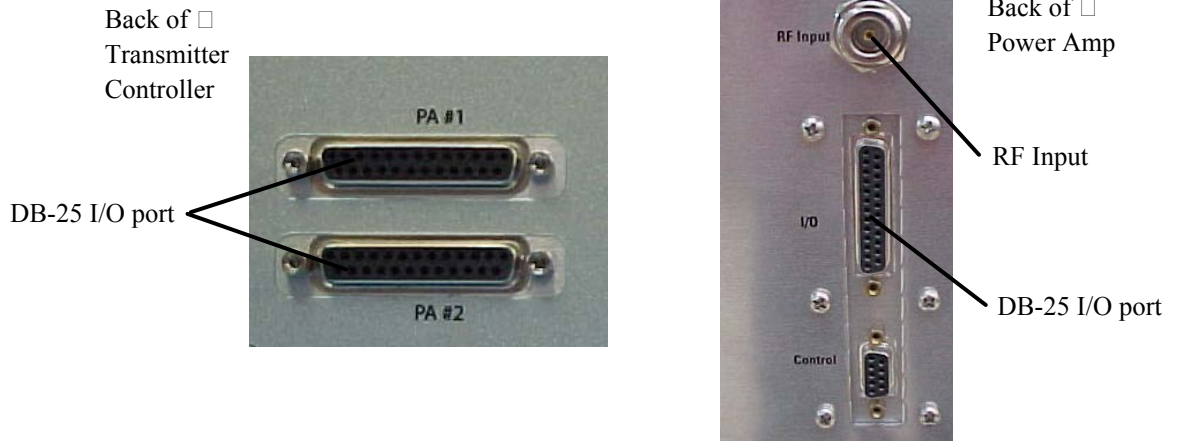


Illustration 2-8 I/O port locations

4) Locate the cable assembly with the "N" type connectors that are connected □ together with a "N" style Female "T". Each of the ends of this assembly □ should connect to the "RF Input" located on the back panel of each PA. This □ cable is RG-11 type and is labeled as such. See Illustration 2-8 for location of □ RF Input. The center of this assembly should have an open female "N" □ connector. Locate the 3 foot RG-214 cable (labeled 101635-1) and attach it □ between this point and the RF output of the FMX250. Refer to Illustration 4-3 on page 4-3 of section 4 for further information.

5) Locate and mount the combiner assembly, including the directional coupler, in a location so that the RF input connectors on the combiner are in close proximity to the RF output connectors of each of the PA's. See Illustration 2-9 for a suggested mounting technique and location.

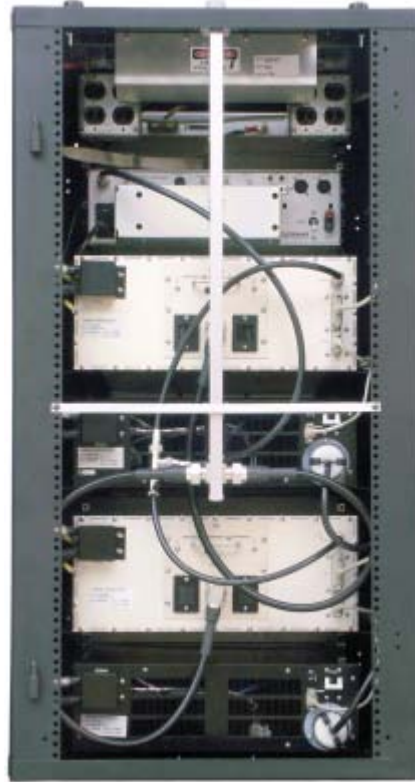


Illustration 2-9 Output Combiner Mounting recommendation

6) Locate the RF Output cables (labeled 200797-CBL) and attach one end to the RF output connector on the back of each PA. Do not tighten the connectors at this point. Attach the other ends to the Combiner as shown in Illustration 2-9. Tighten both ends of the cables at this time.

7) Locate the DB-9 connector on the end of the Directional Coupler and connect it to the DB-9 port labeled 'Directional Coupler' on the back of the Transmitter Controller as shown in Illustration 2-10.

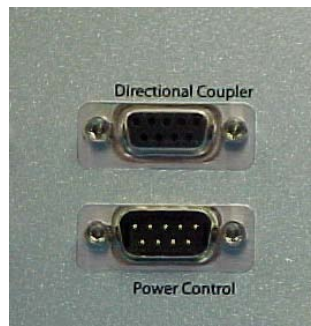


Illustration 2-10 Directional Coupler port and directional coupler

2.5 Installation

2.5.1 AC Power Input Block

!WARNING

Possible Electric *Shock* Hazard!

Do not connect AC source until all other connections are made and installation is complete.

Remove the 4 screws and the AC block cover as shown in Illustration 2-11 for □ access to the AC input block. Save these screws and cover for later re-installation.



Illustration 2-11 AC block access

Attach main AC feed to the appropriate points as labeled in Illustration 2-12.



Illustration 2-12 AC block feed point definition

The AC mains feed-point requires 240 Volts single phase with neutral □ (which allows for 120 Volt supply). The following is the AC feed-point □ supply requirements : □

240 VAC single phase @ 30 Amps □

120 VAC single phase @ 15 Amps (Neutral wire) □

Provide the appropriate supply feed to match these requirements. □

Consult the National Electrical Code for your area for proper conductor □ size and color.

2.5.2 RF Output Connection

The RF Output connection is on the end of the combiner that has the cooling fan □ block installed on it. See illustration 2-13 for the location of the connector. It □ comes standard as a 7/8" EIA Flanged connector. An optional 7/16" DIN □ connector can be ordered if desired.

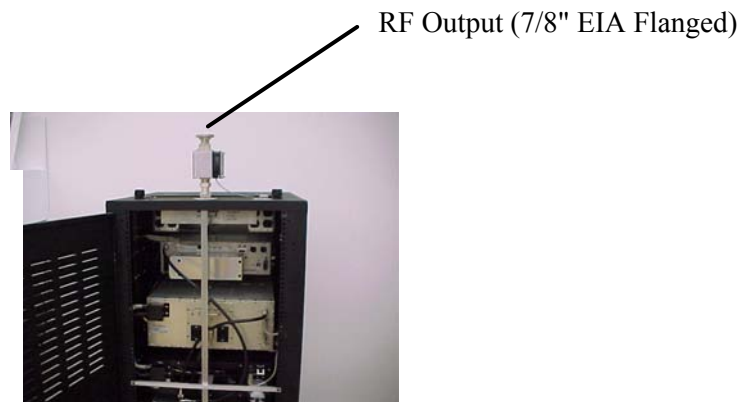


Illustration 2-13 RF Output connection

2.5.3 Audio Input Connection

The Audio input connection is an XLR Female on the back of the FM250 as shown □ below installed in a rack in illustration 2-14.

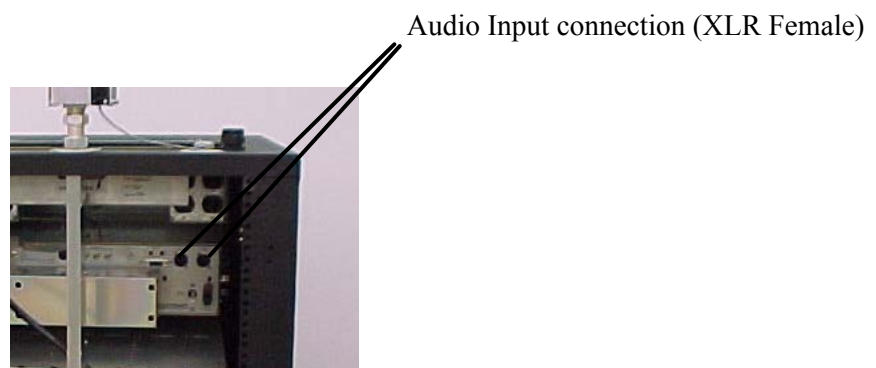
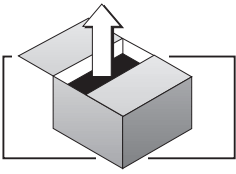


Illustration 2-14 Audio Input connection



2.6 Remote I/O Connection

The DB-25 pin connections PA1-PA5 (on the back of the controller) are where the □ DB-25 Male-to-Male cables are attached from the individual PA2000's. Use PA1 for □ the top amplifier and PA2 for the bottom amplifier. □

The additional I/O connections on the back of the controller consist of 2 main ports; □ Port A (DB-25 Female) and Port C (DB-37 Female) . Port B (DB-37) is not used in □ the FM4000. □

Port A has the metering and control of the System and Port C has the individual □ amplifier metering channels available from each of the PA2000's. □

Other I/O ports are for the reflectometer (DB-9 Female) and an unused power control port (DB-9 Male). I/O port A is described in illustration 2-15 and I/O port B is □ described in illustration 2-16.

Port A	
Pin	Description
1	N/C
2	N/C
3	Ground
4	Remote RF Power RAISE - Momentary to Gnd to raise power 20 watts/second
5	Cabinet Temperature - 0.01 Volts/degrees Celsius reading of internal cabinet temp.
6	Ground
7	Remote High Voltage ON/OFF - Hold to ground to turn ON High Voltage
8	Fault Summary - TTL Logic HIGH (+5 VDC) when any fault light is ON
9	Ground
10	N/C
11	N/C
12	N/C
13	N/C
14	N/C
15	Remote RF Power LOWER - Momentary to Gnd to lower power 20 watts/second
16	N/C
17	N/C
18	Remote RF Power, Forward - 1 VDC = 1000 Watts of Forward power
19	N/C
20	N/C
21	Remote RF Power, Reverse - 1 VDC = 1000 Watts of Reverse power
22	N/C
23	N/C
24	N/C
25	N/C

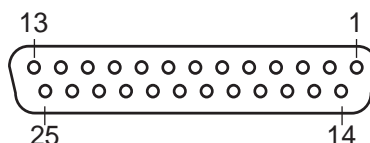


Illustration 2-15 Remote I/O Port A Female DB-25

Port B	
Pin	Description
1	(PA1) RF Power - 1V = 1000 Watts of power
2	(PA1) SWR - Calculated reading of SWR in VDC (1.00 VDC = 1.0 to 1.0 VSWR)
3	(PA1) PA Volts - 1V = 10 V on the PA
4	(PA1) PA Temperature - 1V = 20 degrees Celsius on the PA
5	Ground
6	(PA1) PA Total Current - 1V = 20 A on the PA
7	(PA1) PA#1 current - 1V = 2A of current
8	(PA1) PA#2 current - 1V = 2A of current
9	(PA1) PA#3 current - 1V = 2A of current
10	Ground
11	(PA1) PA#4 current - 1V = 2A of current
12	(PA1) PA#5 current - 1V = 2A of current
13	(PA1) PA#6 current - 1V = 2A of current
14	(PA1) PA#7 current - 1V = 2A of current
15	Ground
16	(PA1) PA#8 current - 1V = 2A of current
17	(PA1) ALC - A direct reading of the ALC voltage on the PA
18	(PA1) In Ref - A DC voltage reference representing RF input power to the PA
19	(PA2) RF Power - 1V = 1000 Watts of power
20	(PA2) SWR - Calculated reading of SWR in VDC (1.00 VDC = 1.0 to 1.0 VSWR)
21	Ground
22	(PA2) PA Volts - 1V = 10 V on the PA
23	(PA2) PA Temperature - 1V = 20 degrees Celsius on the PA
24	(PA2) PA Total Current - 1V = 20 A on the PA
25	(PA2) PA#1 current - 1V = 2A of current
26	Ground
27	(PA2) PA#2 current - 1V = 2A of current
28	(PA2) PA#3 current - 1V = 2A of current
29	(PA2) PA#4 current - 1V = 2A of current
30	(PA2) PA#5 current - 1V = 2A of current
31	Ground
32	(PA2) PA#6 current - 1V = 2A of current
33	(PA2) PA#7 current - 1V = 2A of current
34	(PA2) PA#8 current - 1V = 2A of current
35	(PA2) ALC - A direct reading of the ALC voltage on the PA
36	Ground
37	(PA2) In Ref - A DC voltage reference representing RF input power to the PA

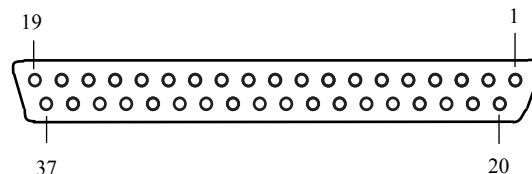
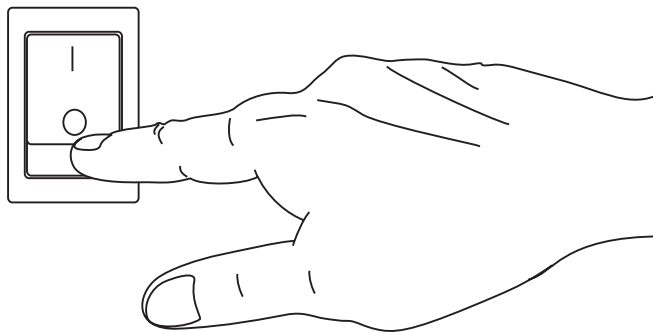
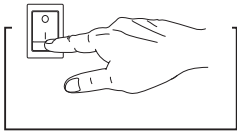


Illustration 2-16 Remote I/O Port B Female DB-37



Section 3—Operation

This section provides general operating parameters of your transmitter system and a detailed description of the front panel displays.



3.1 Initial Power-up Procedures

These steps summarize the operating procedures you should use for the initial operation of the power amplifier and power supply. More detailed information follows.

1. Ensure that the external remote control unit is properly connected to the transmitter controller port A (see illustration 2-15, Section 2.6, page 2–10 for proper pin configuration).
2. Connect Antenna feed-line to the output of the directional coupler.
3. On the Transmitter Controller, locate the Power Control for PA1 and PA2 and adjust these controls fully Counter-Clockwise. (See illustration 3-1).

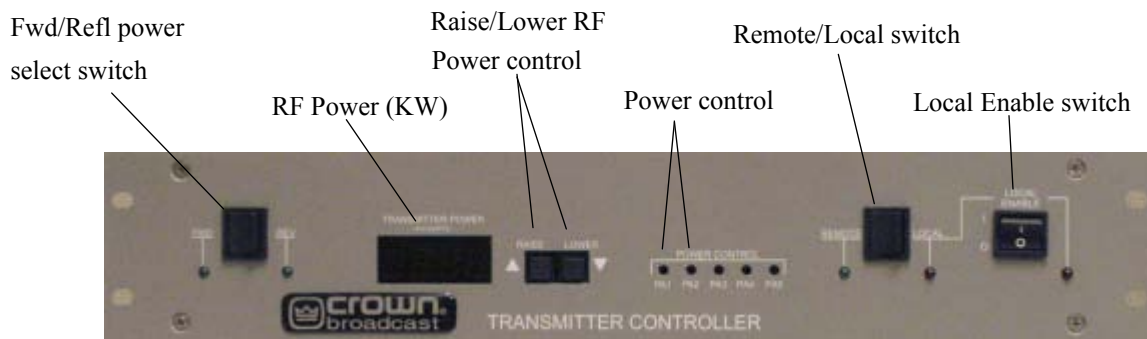


Illustration 3-1 Transmitter Controller Front Panel Controls

4. Turn on (flip up) both of the AC input circuit breakers located on the rear panels of each power supply (do not turn on the front panel switches yet).

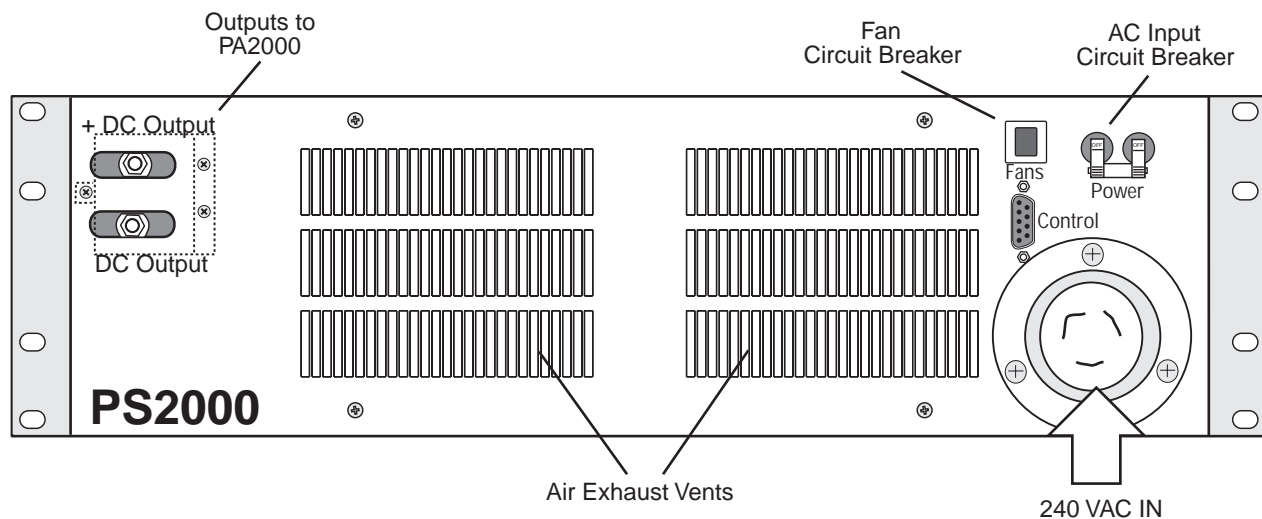


Illustration 3-2 PS2000 Back Panel Functions

5. Turn on the exciter (FM250) and adjust the RF output power for 140 watts. □ This system is not a drive dependent amplifier design; therefore drive level □ must remain constant regardless of main output level. Use remote control to □ raise and lower RF output power, not the RF output level of the driver.

6. Turn on each main power switch located on the front panel of each power supply.

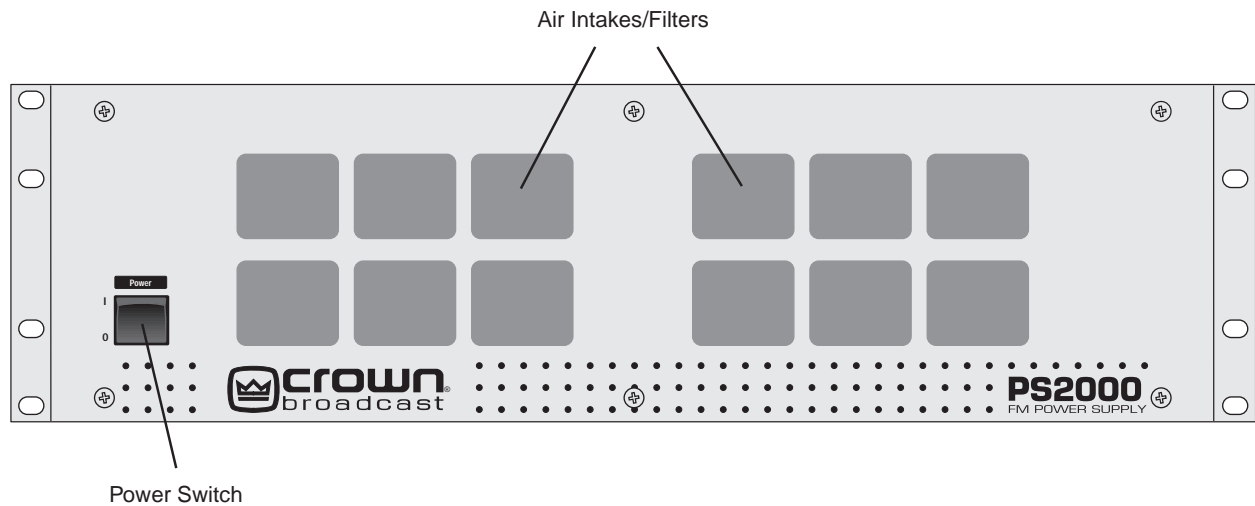


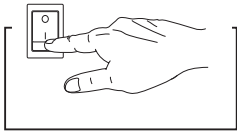
Illustration 3-3 PS2000 Front Panel Functions

7. If a remote control is being used, enable the power supply using the remote control unit. If not, one of two methods should be done. The first method is to locate the Remote/Local switch on the Transmitter Controller and select "Local" then enable the Local control with the "Local Enable" switch by turning it to the ON position (up). The second method is to keep the Remote/Local switch in the "Remote" position and short pins 6 and 7 of Port A together on the Transmitter Controller. When either of these methods are completed, the power supplies should turn on (the supplies typically take 30 - 45 seconds to power up.)

NOTE : During power up, it is normal to observe a VSWR fault condition on one or both of the amplifiers. However, if after a minute or two the fault does not clear itself, consult the factory for additional help. Also, if there is greater than 200 watts difference between each amplifier, this condition could occur as well. Adjust the power control pots for an RF power difference of less than 200 watts.

8. Adjust the PA1 and PA2 controls on the Transmitter Controller alternately in less than 200 watt increments until the desired output is achieved as read by the display and/or an external watt meter. When reaching the final output power level, ensure that the RF power output from each of the PA's are within 100 watts of each other to ensure best performance of the combiner. These settings will limit the maximum output power that the system can achieve. To set the limit at a lower value, the "local" power adjust pot (Power set R62) located behind the front panel of each PA2000 can be adjusted as well.

Note : The local power set pot is unconventional in that a Clock-wise rotation will lower the power instead of raise the power.



-
9. Verify that the following conditions are present as indicated by each PA2000's Digital Multimeter:
- In Ref—Should read between 0.4 and 0.8 volts (0.5 nominal, dependent upon power input level).
 - SWR—Should read 1.05 to 1.5.
 - ALC—Should read between 4.00 and 6.00 volts for 2.2 kW output (less for lower output or danger conditions, i.e. high SWR).
 - Power Out—Should read 2.20 for 2.2 kW output.
 - PA Temp—Should read 35 to 50°C with ambient temperature of 25°C.

The remainder of this section describes the functions of the front and rear panel indicators and switches of the Transmitter Controller.

3.2 Power Switches

3.2.1 AC Input Power switch

The Transmitter Controller's AC power is controlled by a switch located on the AC input filter. The AC input range is 100-250 VAC. The fuse type and size are 3AGC at 1/2 amp slo-blo and there are 2 fuses. See illustration 3-4 for switch location.

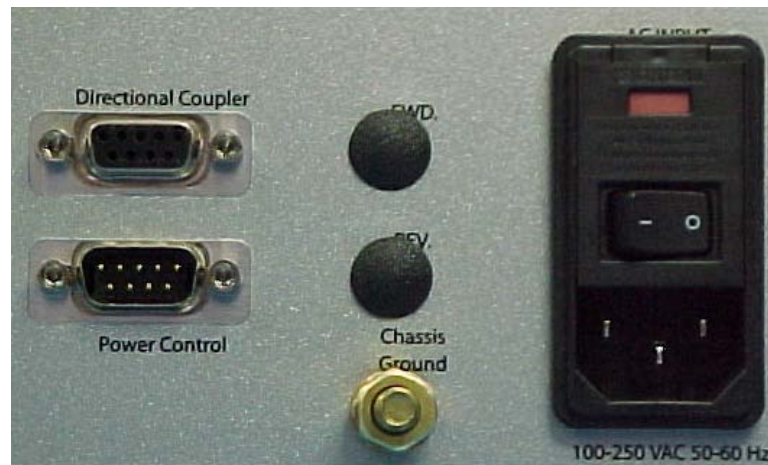


Illustration 3-4 AC Input Power Switch

3.3 Front Panel Controls and Display

Refer to illustration 3-1 for additional information when going through section 3.3.

3.3.1 Remote/Local Switch

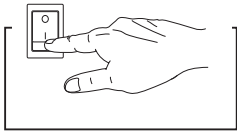
The Remote/Local switch is used to be able to 'break' the interlock line from the remote control unit to allow for local control of the High Voltage supply that feeds the PA's. It has a green LED which illuminates when the switch is in the remote position (allowing for control via remote control unit) and a red LED which will illuminate when the switch is in the local position (disabling the remote control from turning on the high voltage). See illustration 3-5.



Illustration 3-5 Remote/Local and Local Enable switches with indicators

3.3.2 Local Enable Switch

The Local Enable Switch is used to enable the high voltage supply for the PA's when the Transmitter Controller is in the 'Local' mode. The switch in the ON position (up, or logic level 1) will enable the supplies and illuminate the red indicator LED. The switch in the OFF position (down, or logic level 0) will disable the supplies and extinguish the red LED. See illustration 3-5.



3.3.3 Transmitter RF Power Control

The Transmitter Controller has the ability to internally set the maximum RF output power for the 4000 watt system using the power control setting for each PA. These controls are located behind the front panel and have an access hole in front of each control. A small flat blade screwdriver is needed to adjust each control. For maximum output level, these controls need to be set fully Clock-wise. Adjust the controls for each PA separately (PA1 and PA2) in small steps (less than 100 watts difference) to prevent any unnecessary VSWR problems to the other amplifier (the one not being adjusted). These controls will effect the final RF output power that the remote control can adjust to. Whatever these are set for as a maximum level, that level is all the higher the remote control will be able to set the power to. See illustration 3-6 for location of these controls.



Illustration 3-6 Power Control Adjustment location

3.3.4 Raise/Lower RF Power Control

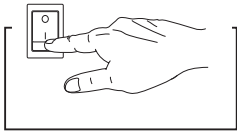
The Transmitter Controller has the ability to Raise or Lower the RF Power in small increments using the control switches on the front panel. Refer to illustration 3-6 for the location of these controls. To raise the power, depress the switch under the "Raise" label. Press and hold this switch to change the power in 40 watts/second increments. Pressing once should only change the power 20 watts. To lower the power, depress the switch under the "Lower" label. Press and hold this switch to change the power in 40 watts/second increments. Pressing this switch once will change the power 20 watts. Both switches are momentary contact type switches and parallel the remote control for Raising and Lowering power via Port A on the back of the unit. A remote control unit is not required for this operation. These controls will change the RF output power on both PA's simultaneously, reducing the need for separate controls for each PA.

3.3.5 RF power reading and selector switch

The Transmitter Controller has a digital panel meter which displays Forward RF Power and Reverse RF Power as detected by the RF power sampler attached to the end of the combiner. The reading on the display is determined by the setting of the selector switch and accompanying green LED indicator. The readings are in KiloWatts and have an accuracy of better than 2%. However, it is recommended that an external watt meter be used for a more accurate reading. See illustration 3-7 for the location of the panel meter and selector switch with accompanying green LED indicators.



Illustration 3-7 RF Power Reading and Selector Switch



3.4 Rear Panel connections

The Transmitter Controller has several types of connections on the rear panel of the unit. The following will describe each type and what it is used for. See illustration 3-8 for location of each connector. Refer to Section 2.6 illustrations 2-7 and 2-8 for detailed descriptions of each applicable remote control connector.

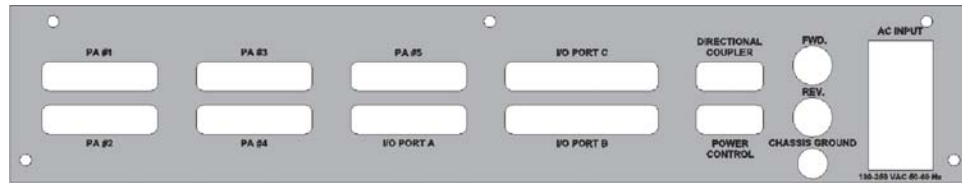


Illustration 3-8 Rear panel connections

3.4.1 DB-25

There are six (three, dual vertically stacked) DB-25 female connectors on the back of the Transmitter Controller. PA1 and PA2 are what is used to connect to the DB-25 remote I/O on the back of each PA using the supplied DB-25 Male-to-Male cables. The connectors labeled PA3, PA4, and PA5 are not used for the FM4000. The last connector labeled I/O Port A is used for the Remote Interface and has the final output metering information as well as the system controls for power control and high voltage control. See illustration 2-7 on page 2-7 for a detailed description of what each pin is used for.

3.4.2 DB-37

There are two (one, dual vertically stacked) DB-37 female connectors on the back of the Transmitter Controller. Port B is used for the Remote interface and has all the metering channels found on both PA1 and PA2 routed to this connector. Port C is not used on the FM4000. See illustration 2-8 on page 2-8 for a detailed description of what each pin is used for.

3.4.3 DB-9

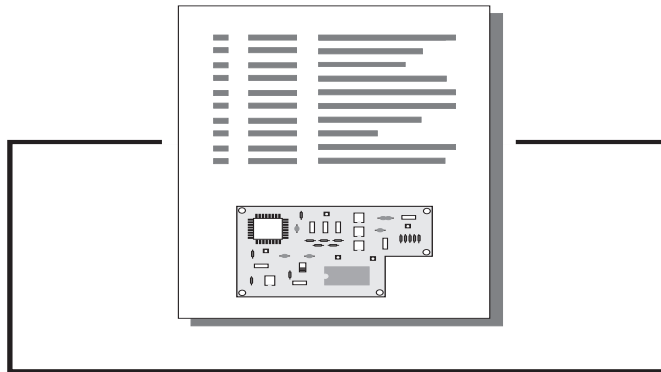
There is one DB-9 female connector and one DB-9 male connector (vertically stacked) on the back of the Transmitter Controller. The port labeled Directional Coupler is used to connect to the directional coupler mounted at the output of the combiner. Its primary function is to bring into the controller the forward and reverse power information that the controller uses to display on the front panel meter. Its secondary function is to provide a supply voltage to the temperature sensor located inside the connector shell of the cable that connects to the directional coupler for cabinet temperature reading available on I/O port A. It also provides fan voltage as well for cooling the coupler. The port labeled power control is not used in the FM4000.

3.4.4 BNC Connectors

The Transmitter Controller has provisions for two BNC connectors on the back panel labeled Fwd and Rev. Neither of these connectors are used in the FM4000, therefore, hole plugs are used in their place.

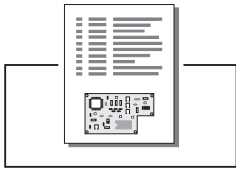
3.4.5 Chassis Ground

The Transmitter Controller has a provision to connect the chassis to your station ground. Use a copper strap or braid to connect the station ground to the 1/4-20 brass stud provided on the back panel of the unit.



Section 4—Reference Drawings

The illustrations in this section may be useful for making adjustments, taking measurements, troubleshooting, or understanding the circuitry of your RF power amplifier and power supply.



4.1 Views



Illustration 4-1 Front View

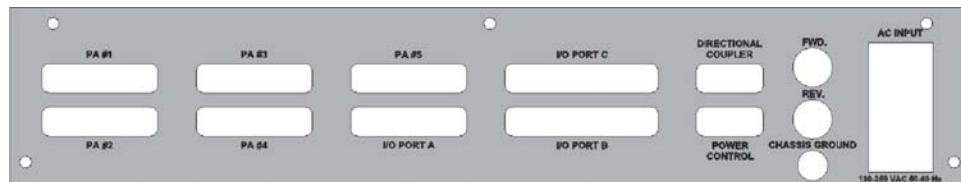
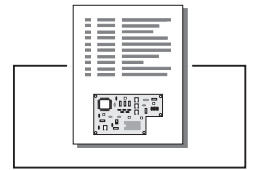
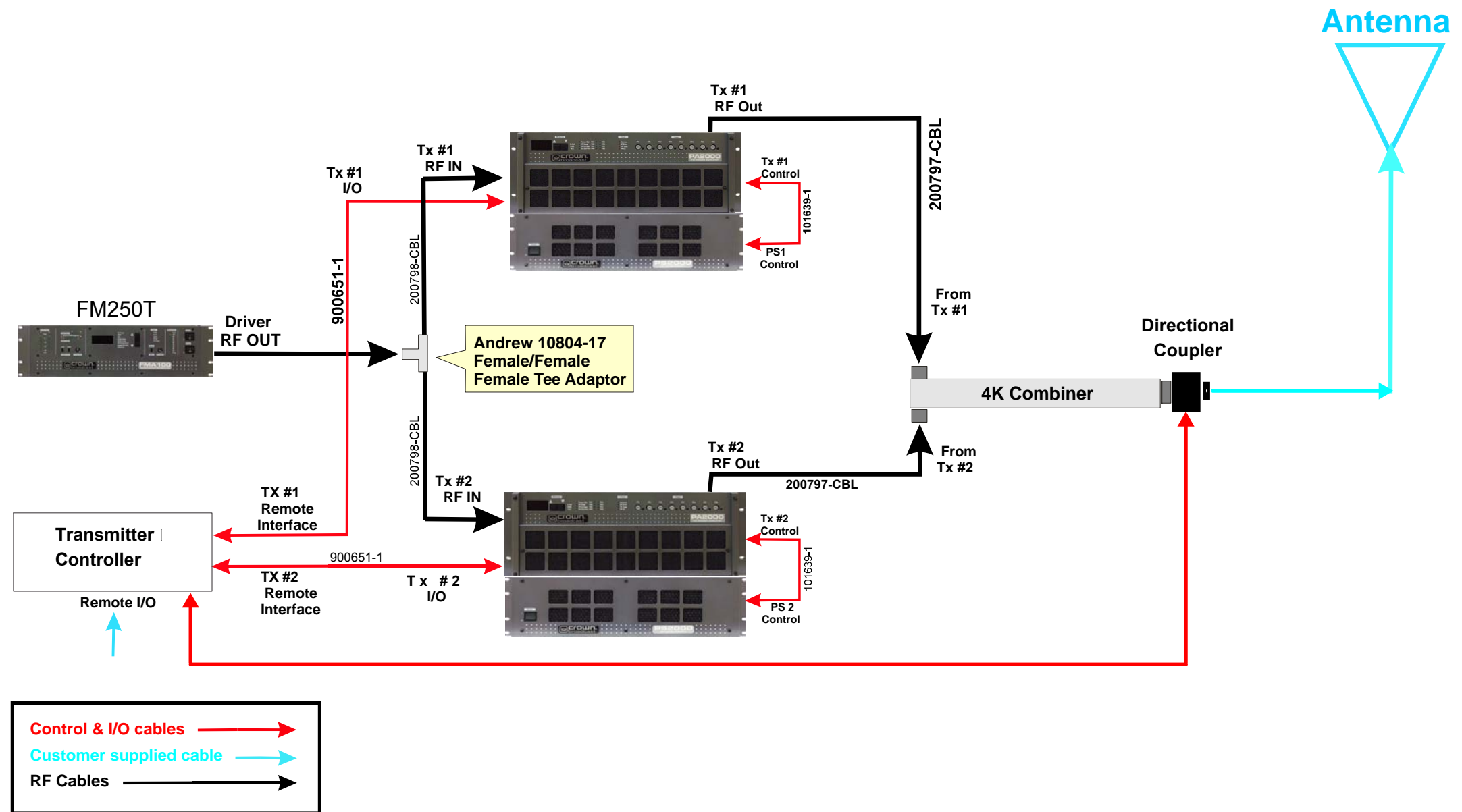


Illustration 4-2 Back View

4.2 Block Diagram



FM4000 Transmitter System

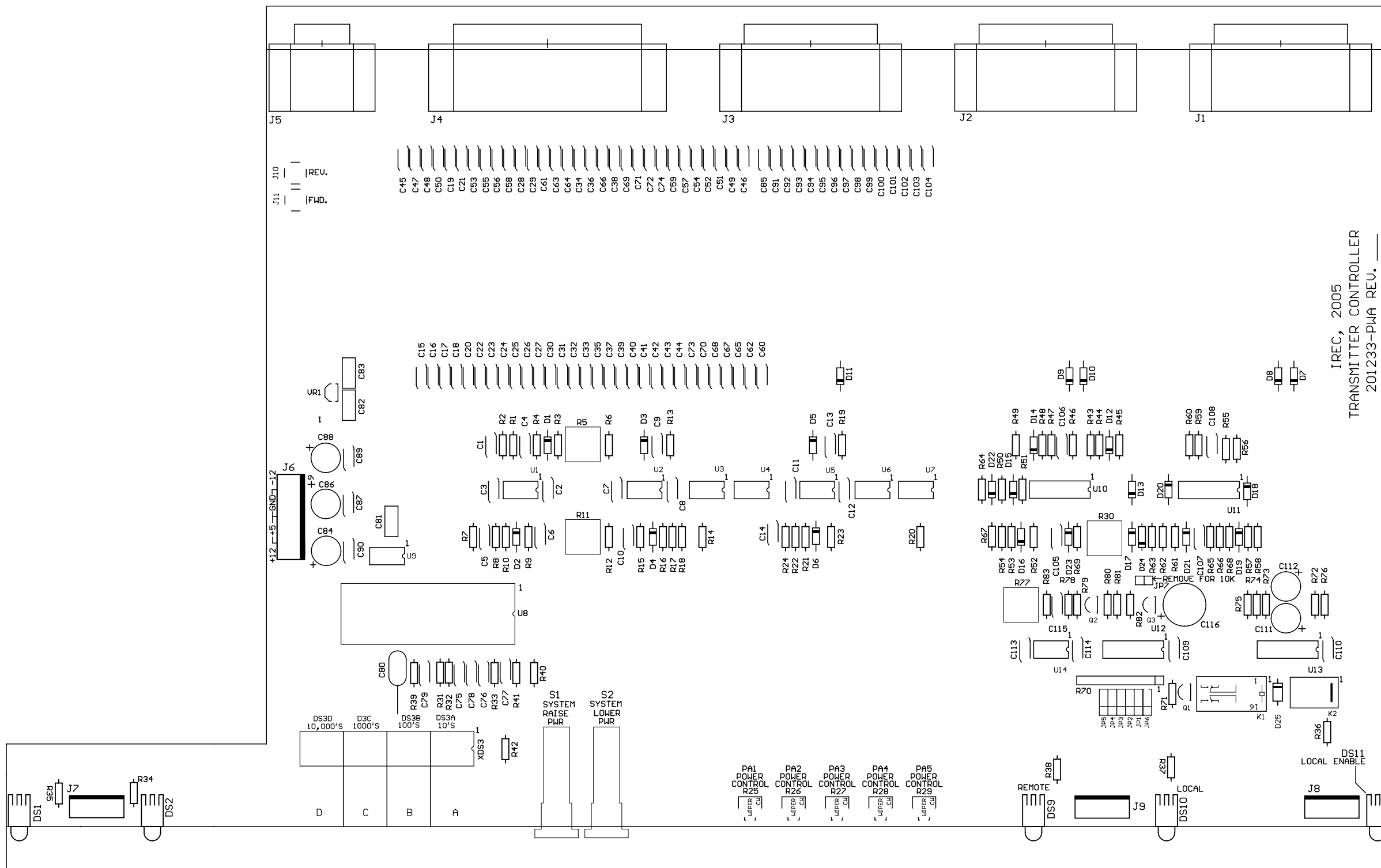


4K Combined System
 DP/ csd 5-12-05
 IREC

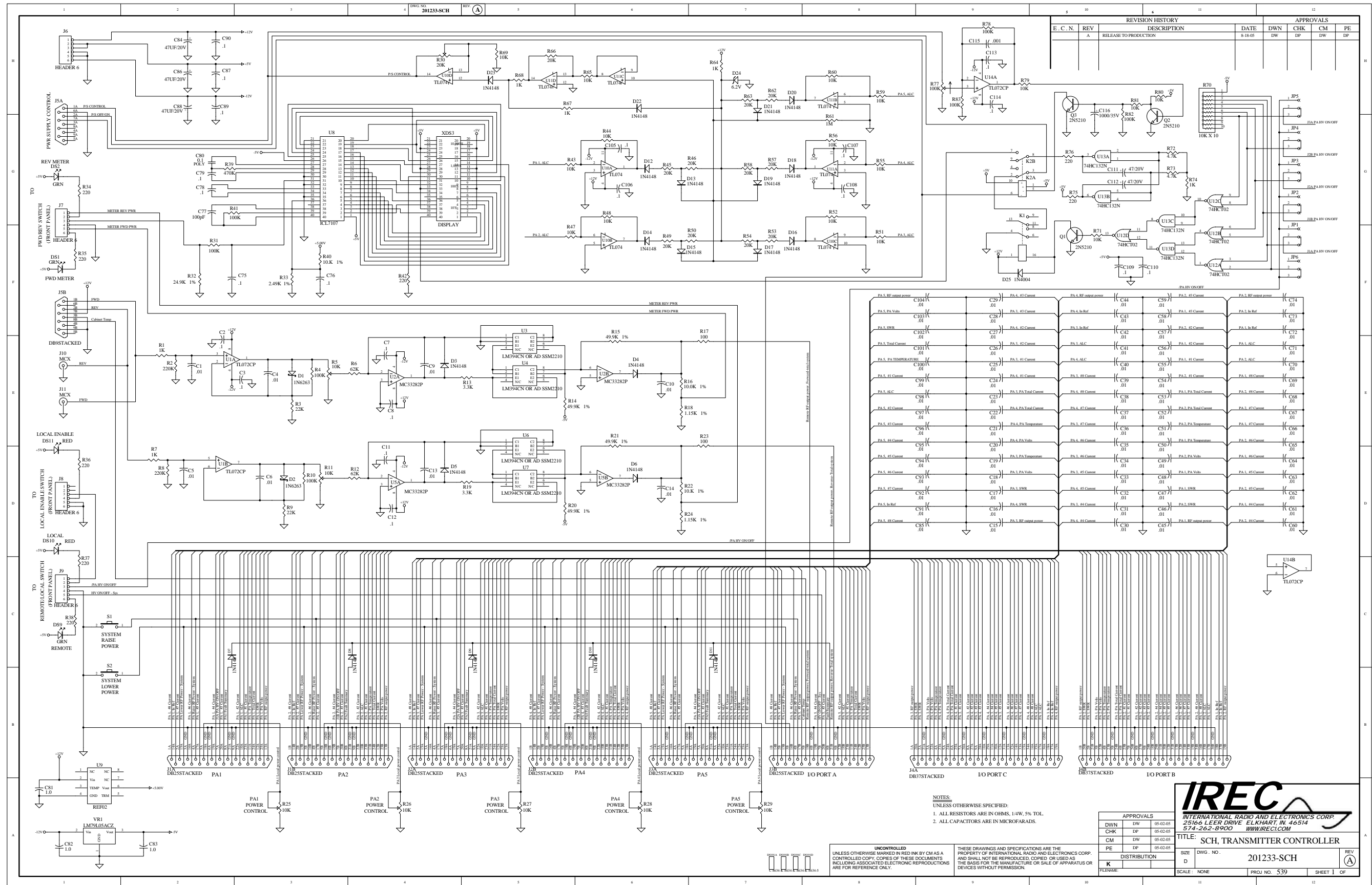
Illustration 4-3 FM4000 Block Diagram

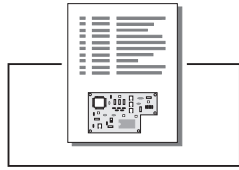
4.3 Transmitter Controller Board Component ID

Top Overlay



4.4 Transmitter controller Board Schematic







Section 5—Service and Support

We understand that you may need various levels of support or that the product could require servicing at some point in time. This section provides information for both of these scenarios.



5.1 Service

The product warranty (see opposite page) outlines our responsibility for defective products. Before returning a product for repair or replacement (our choice), call our Customer Service department using the following telephone number:

(866) 262-8917

Our Customer Service Representative will give you further instructions regarding the return of your product. Use the original shipping carton or a new one obtained from Crown. Place shipping spacers between the slide-out power amplifier assembly and the back panel.

Please fill out the Factory Service Instructions sheet (page 7-5) and include it with your returned product.

5.2 24-Hour Support

In most instances, what you need to know about your product can be found in this manual. There are times when you may need more in-depth information or even emergency-type information. We provide 24-hour technical assistance on your product via a toll telephone call.

For **emergency help** or **detailed technical assistance**, call

(866) 262-8917

You may be required to leave a message at this number but your call will be returned promptly from our on-call technician.

5.3 Spare Parts

To obtain spare parts, call **Crown Broadcast Sales** at the following number.

(866) 262-8917

You may also write to the following address:

Service Manger

International Radio and Electronics Company, Inc.

25166 Leer Drive

Elkhart, Indiana, U.S.A. 46514-5425

Crown Broadcast Three Year Limited Product Warranty

SUMMARY OF WARRANTY

Crown Broadcast, IREC warrants its broadcast products to the ORIGINAL PURCHASER of a NEW Crown Broadcast product, for a period of three (3) years after shipment from Crown Broadcast. All products are warranted to be free of defects in materials and workmanship and meet or exceed all specifications published by Crown Broadcast. Product nameplate with serial number must be intact and not altered in any way. This warranty is non-transferable. This warranty in its entirety is the only warranty offered by Crown Broadcast. No other warranties, expressed or implied, will be enforceable.

EXCLUSIONS

Crown Broadcast will not warranty the product due to misuse, accident, neglect and improper installation or operation. Proper installation included A/C line surge suppression, lightning protection and proper grounding of the entire transmitter, and any other recommendations designated in the Instruction manual. This warranty does not extend to any other products other than those designed and manufactured by Crown Broadcast. This warranty does not cover any damage to any accessory such as loads, transmission line or antennas resulting from the use or failure of a Crown Broadcast transmitter. Warranty does not cover any loss of revenue resulting from any failure of a Crown Broadcast product, act of God, or natural disaster.

Procedure for Obtaining Warranty Service

Crown Broadcast will repair or service, at our discretion, any product failure as a result of normal intended use. Warranty repair can only be performed at our plant facility in Elkhart, Indiana USA or at a factory authorized service depot. Expenses in remedying the defect will be borne by Crown Broadcast, including two-way ground transportation cost within the continental United States.

Prior to returning any product or component to Crown Broadcast for warranty work or repair, a Return Authorization (RA) number must be obtained from the Crown Broadcast Customer Service Department. Product must be returned in the original factory pack or equivalent. Original factory pack materials may be obtained at a nominal charge by contacting Crown Broadcast Customer Service. Resolution of the defective product will be made within a reasonable time from the date of receipt of the defective product.

Warranty Alterations

No person has the authority to enlarge, amend, or modify this warranty, in whole or in part. This warranty is not extended by the length of time for which the owner was deprived the use of the product. Repairs and replacement parts that are provided under the terms of this warranty shall carry only the unexpired portion of the warranty.

Product Design Changes

Crown Broadcast reserves the right to change the design and manufacture of any product at any time without notice and without obligation to make corresponding changes in products previously manufactured.

Legal Remedies of Purchaser

This written warranty is given in lieu of any oral or implied warranties not covered herein. Crown Broadcast disclaims all implied warranties including any warranties of merchantability or fitness for a particular purpose.

Crown Broadcast

25166 Leer Drive

Elkhart, Indiana 46514-5425

Phone 574-262-8900 Fax 574-262-5399 www.crownbroadcast.com

Factory Service Instructions

To obtain factory service, complete the bottom half of this page, include it with the unit, and ship to:

International Radio and Electronics Company, Inc.
25166 Leer Drive
Elkhart, Indiana, U.S.A. 46514-5425

For units in warranty (within 3 years of purchase from any authorized Crown Dealer): We pay for ground UPS shipments from anywhere in the continental U.S. and Federal Express Second Day service from Hawaii and Alaska to the factory and back to you. Expedited service/shipment is available for an additional charge. You may ship freight collect (COD for cost of freight) or forward your receipt for shipping charges which we will reimburse. We do not cover any charges for shipping outside the U.S. or any of the expenses involved in clearing customs.

If you have any questions about your Crown Broadcast product, please contact Crown Broadcast Customer Service at:

Telephone: (866) 262-8917 or (574) 262-8900
Fax: (574) 262-5399

Name: _____ Company: _____

Shipping Address: _____

Phone Number: _____ Fax: _____

Model: _____ Serial Number: _____ Purchase Date: _____

Nature of the Problem

(Describe the conditions that existed when the problem occurred and what attempts were made to correct it.)

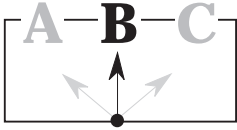
Other equipment in your system: _____

If warranty has expired, payment will be: Cash/Check VISA Mastercard COD
 Please Quote before servicing

Card Number: _____ Exp. Date: _____ Signature: _____

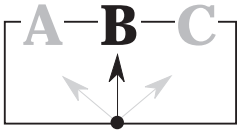
Return Shipment Preference if other than UPS Ground: Expedite Shipment Other _____

ENCLOSE WITH UNIT—DO NOT MAIL SEPARATELY



AF	Audio Frequency; the frequencies between 20 Hz and 20 kHz in the electromagnetic spectrum.
ALC	Automatic Level Control
AM	Amplitude Modulation; the process of impressing information on a radio-frequency signal by varying its amplitude.
bandwidth	The range of frequencies available for signalling.
BCD	Binary-Coded Decimal; a digital system that uses binary codes to represent decimal digits.
BFO	Beat Frequency Oscillator
BNC	A bayonet locking connector for miniature coax; said to be short for Bayonet-Neill-Concelman.
broadband	As used in the FM transmitter, refers to the entire audio spectrum as opposed to the spectrum influenced by the pre-emphasis; also called "Wideband."
carrier	A continuous signal which is modulated with a second, information-carrying signal.
crosstalk	In FM broadcasting, this term generally refers to the interaction between the main (L+R) and the subcarrier (L-R) signals as opposed to "separation" which generally refers to leakage between left (L) and right (R) channels.
density (program)	A high average of modulation over time.
deviation	The amount by which the carrier frequency changes either side of the center frequency.
DIP	Dual In-line Package; term used to describe an IC or socket that has two parallel rows of pins.
distortion	The unwanted changes in signal wave shape that occur during transmission between two points.
DPM	Digital Panel Meter
EPROM	Erasable Programmable Read Only Memory
ESD	Electrostatic Discharge; a discharge that is potentially destructive to sensitive electronic components.

exciter	(1) A circuit that supplies the initial oscillator used in the driver stage. (2) A transmitter configuration which excludes stereo generation and audio processing.
FET	Field-Effect Transistor
frequency synthesizer	A circuit that generates precise frequency signals by means of a single crystal oscillator in conjunction with frequency dividers and multipliers.
FM	Frequency Modulation; the process of impressing information on a radio signal by varying its frequency.
FSK	Frequency Shift Keying; an FM technique for shifting the frequency of the main carrier at a Morse code rate. Used in the on-air identification of frequencies.
gain reduction	The process of reducing the gain of a given amplifier.
harmonics	Undesirable energy at integral multiples of a desired, fundamental frequency.
HF	High Frequency; Frequencies in the 3.0 to 30.0 MHz range.
Highband	Frequencies affected by the pre-emphasis.
IC	Integrated Circuit
I/O	Input/Output
LED	Light-Emitting Diode
modulation	The process by which a carrier is varied to represent an information-carrying signal.
MOSFET	Metal Oxide Semiconductor Field Effect Transistor; a voltage-controlled device with high input impedance due to its electrically isolated gate.
nearcast	A transmission within a localized geographic area (ranging from a single room to a several kilometers).
PA	Power Amplifier



PAI	Power Amplifier Current
PAV	Power Amplifier Voltage
pilot	A 19-kHz signal used for stereo transmissions.
pre-emphasis	The deliberate accentuation of the higher audio frequencies; made possible by a high-pass filter.
processing	The procedure and/or circuits used to modify incoming audio (keeping its level around 75 kHz deviation) to make it suitable for transmission.
receiver	An option which adds incoming RF capability to an existing transmitter. See also "Translator."
RF	Radio Frequency; (1) A specific portion of the electromagnetic spectrum between audio-frequency and the infrared portion. (2) A frequency useful for radio transmission (roughly 10 kHz and 100,000 MHz).
SCA	Subsidiary Communications Authorization; see "subcarrier."
S/N	Signal to Noise
spurious products	Unintended signals present on the transmission output terminal.
stability	A tolerance or measure of how well a component, circuit, or system maintains constant operating conditions over a period of time.
stereo pilot	See "pilot."
stereo separation	The amount of left-channel information that bleeds into the right channel (or vice versa).
subcarrier	A carrier signal which operates at a lower frequency than the main carrier frequency and which modulates the main carrier.
suppression	The process used to hold back or stop certain frequencies.

SWR	Standing-Wave Ratio; on a transmission line, the ratio of the maximum voltage to the minimum voltage or maximum current to the minimum current; also the ratio of load impedance to intended (50 ohms) load impedance.
THD	Total Harmonic Distortion
translator	A transmitter designed to internally change an FM signal from one frequency to another for retransmission. Used in conjunction with terrestrial-fed networks.
satellator	A transmitter equipped with an FSK ID option for rebroadcasting a satellite-fed signal.
UHF	Ultra High Frequency; frequencies in the 300 to 3000 MHz range.
VCO	Voltage-Controlled Oscillator
VHF	Very High Frequency; frequencies in the 30 to 300 MHz range.
VSWR	Voltage Standing-Wave Ratio; see "SWR."
Wideband	See "broadband."

Index

A

AC Power 1-5, 2-8
AC power 2-4, 3-4
ALC 2-11, 3-4, G-2
Antenna 3-2, 4-3
antenna 5-3

B

Board Layouts 4-4

C

Circuit Breaker 3-2
Combiner 1-2, 2-7, 2-9,
3-3, 3-8, 4-3
Connections 2-10
Connectors
 Hubble Twist Lock® 2-4
connectors 2-3, 2-6, 2-7,
3-8, 3-9

D

DC Power Switch 3-5
Digital Multimeter 3-6, 5-3

E

Efficiency 1-3
efficiency 1-2
exciter 1-2

F

Fans 4-4, 4-6, 5-5
Fault Indicators 3-7, 5-5
Frequency Range 1-3
Fuse Indicators 3-8

H

Humidity Range 1-3

I

In Ref 3-4, 5-3
Input Divider Board 4-3
Installation 2-5
Interlock Switch 3-5

L

labels 1-4

M

Metering and Control Board 4-4
multimeter display 3-4

O

operation 3-2
Output Combiner Board 4-3
Output Filter & Reflectometer 4-3

P

PA DC 5-6
PA Temp 3-4, 5-4
PA Voltage 5-4
PFC (Power Factor Correcting)
 Switching Board 4-5
power adjust 3-3
Power Consumption 1-3
Power Factor 1-3
Power Module 4-2
Power Out 3-4, 5-3
Power Switch 3-4
power switch 3-3
Power-up 3-2

R

remote I/O 2-7
RF Drive Requirement 1-3
RF Harmonics 1-3
RF Output Impedance 1-3
RF output power 1-2
RF Power Output 1-3
RF power output 1-2
RU spaces 1-2

S

S/N Ratio 1-3
Safety 1-4
Schematics 6-3
Spurious Products 1-3
SWR 1-3, 3-4, 5-3

T

Tot Current 5-4
transmitter package 1-2
Troubleshooting Flow Chart 5-2

U

Unpacking 2-2

W

Weight 1-3