



EUROPEAN
TELECOMMUNICATION
STANDARD

ETS 300 384

January 1995

Source: EBU/ETSI JTC

Reference: DE/JTC-VHFTX

ICS: 33.060

Key words: Audio, broadcasting, FM, transmitter, VHF

European Broadcasting Union



Union Européenne de Radio-Télévision

**Radio broadcasting systems;
Very High Frequency (VHF), frequency modulated,
sound broadcasting transmitters**

ETSI

European Telecommunications Standards Institute

ETSI Secretariat

Postal address: F-06921 Sophia Antipolis CEDEX - FRANCE

Office address: 650 Route des Lucioles - Sophia Antipolis - Valbonne - FRANCE

X.400: c=fr, a=atlas, p=etsi, s=secretariat - **Internet:** secretariat@etsi.fr

Tel.: +33 92 94 42 00 - Fax: +33 93 65 47 16

Copyright Notification: No part may be reproduced except as authorized by written permission. The copyright and the foregoing restriction extend to reproduction in all media.

© European Telecommunications Standards Institute 1995. All rights reserved.

© European Broadcasting Union 1995. . All rights reserved.

Contents

Foreword	5
1 Scope	7
2 Normative references	7
3 Definitions and abbreviation	8
3.1 Definitions	8
3.2 Abbreviations	8
4 Technical requirements	9
4.1 Characteristics of RF interface ports	9
4.2 Transmitter input configuration	9
4.3 Transmitter output characteristics	9
4.4 Frequency range	10
4.5 Frequency stability	10
4.5.1 Frequency error	10
4.5.2 Frequency drift	10
4.6 Frequency adjustment	10
4.7 Unwanted frequency shift	10
4.8 Frequency deviation	10
4.9 Overdeviation	10
4.10 Deviation sensitivity stability	11
4.11 Unwanted emissions	11
4.11.1 Spurious emissions	11
4.11.2 Out-of-band emissions - stereophonic transmitters	11
4.11.3 Out-of-band emissions - monophonic transmitters	11
4.12 Amplitude Modulation (AM)	11
4.12.1 Synchronous AM (AM due to FM)	11
4.12.2 Hum and noise (residual AM)	12
4.13 Test load characteristics	12
5 Operating and test conditions	13
5.1 Normal operating and test conditions	13
5.2 Extreme operating and test conditions	13
Annex A (normative): Stereo test encoder for pilot tone system, audio and multiplex parameters	18
A.1 Introduction	18
A.2 Input parameters	18
A.2.1 Audio inputs	18
A.2.2 Auxiliary inputs	18
A.2.2.1 Impedance	18
A.2.2.2 Gain	18
A.3 Pilot signal	18
A.3.1 Pilot tone	18
A.3.2 Pilot tone output	18
A.3.3 External pilot synchronising	19
A.4 Output	19
A.4.1 MPX coded signal	19
A.4.2 Level of the MPX coded signal	19
A.4.3 Spurious frequencies	19

A.5	Non linear distortion	20
A.5.1	Harmonic distortion of the encoder	20
A.5.2	Base-band frequency intermodulation products of the encoder.....	20
A.5.3	Distortion products of the decoder	20
A.6	Signal to Noise ratio (S/N)	20
A.6.1	Unweighted S/N	20
A.6.2	Weighted S/N	20
A.7	Linear distortion	20
A.7.1	AF channel amplitude difference.....	20
A.7.2	Auxiliary input	20
A.8	Linear crosstalk	21
A.8.1	Crosstalk attenuation between the M and S channels	21
A.8.2	Crosstalk attenuation between the two AF channels	21
Annex B (normative):	RF Spectrum measurements to detect excessive spectrum pollution due to abnormal AF - input levels	22
B.1	Measuring arrangement	22
B.2	Measuring procedure.....	22
B.3	Presentation of the results	22
Annex C (informative):	General conditions of operation	23
C.1	Temperature in the operating room	23
C.2	Relative humidity in the operating room	23
C.3	Cooling air temperature	23
C.4	Relative humidity of the air entering the cooling system up to 25°C.....	23
C.5	Air pressure	23
C.6	Immunity against mechanical vibrations airborne or air pressure	23
C.7	Immunity against electric field strength within the broadcasting bands.....	23
C.8	Immunity against magnetic field strength	23
C.9	Mains voltage.....	23
C.10	Mains frequency	23
Annex D (normative):	Reverse intermodulation measurements.....	24
D.1	Scope of annex.....	24
D.2	Measurement arrangement	24
D.3	Principle of measurement.....	24
D.4	Measurement routine.....	25
Annex E (informative):	Bibliography	26
History	27

Foreword

This European Telecommunication Standard (ETS) has been produced under the authority of the Joint Technical Committee (JTC) of the European Broadcasting Union (EBU) and the European Telecommunications Standards Institute (ETSI).

This ETS defines the performance characteristics of Very High Frequency (VHF), frequency modulated, monophonic and stereophonic sound broadcasting transmitters operating in the frequency band 87,5 MHz to 108 MHz.

NOTE: The EBU/ETSI JTC was established in 1990 to co-ordinate the drafting of ETSs in the specific fields of radio, television and data broadcasting. The EBU is a professional association of broadcasting organizations whose work includes co-ordination of its Members activities in the technical, legal, programme-making and programme-exchange domains. The EBU has active members in about 60 countries in the European broadcasting area; its headquarters is in Geneva,

European Broadcasting Union
Case Postale 67
CH-1218 GRAND SACONNEX (Geneva)
Switzerland

Tel: +44 22 7172111
Fax: +44 22 7985897

Blank page

1 Scope

This European Telecommunication Standard (ETS) covers those performance requirements for Very High Frequency (VHF) Frequency Modulation (FM) sound broadcasting transmitters operating in the frequency band 87,5 MHz to 108 MHz, and modulated in accordance with CCIR Recommendation 450-1 [1], which has some bearing on the Radio Frequency (RF) spectrum. Monophonic signals are transmitted in accordance with section 1, and stereophonic signals in accordance with section 2.2 (pilot tone system) of CCIR Recommendation 450-1 [1]. This ETS also covers the transmission of supplementary signals as described in CCIR Recommendation 450-1 [1] and/or EN 50067 [2].

This ETS considers only those technical characteristics that relate to the radiated signal and hence directly affect the efficient use of RF spectrum.

The use of CCIR Recommendation 412-5 [3] for planning sound broadcasting services is assumed.

Spurious and out-of-band emission limits specified in figures 1 and 3 respectively are incorporated to protect both aeronautical navigation and communication services operating in the frequency band 108 MHz to 137 MHz and rebroadcast reception in the frequency band 87,5 MHz to 108 MHz.

In those areas where reliance on a transmitter specification alone cannot guarantee protection of the RF spectrum (e.g. reverse intermodulation), recommendations appropriate to installed systems are described in ETSI Technical Report (ETR) 132 [8].

Electro Magnetic Compatibility (EMC) aspects for equipment covered by this ETS are given in ETS 300 447 (see annex E, bibliography).

2 Normative references

This ETS incorporates by dated and undated reference, provisions from other publications. These normative references are cited at the appropriate places in the text and the publications are listed hereafter. For dated references, subsequent amendments to or revisions of any of these publications apply to this ETS only when incorporated in it by amendment or revision. For undated references, the latest edition of the publication referred to applies.

- [1] CCIR Recommendation 450-1 (1982): "Transmission standards for FM sound broadcasting at VHF".
- [2] EN 50067: "Specification of the Radio Data System (RDS)".
- [3] CCIR Recommendation 412-5 (1990): "Planning standards for FM sound broadcasting at VHF".
- [4] IEC 244-1: "General conditions of measurements, frequency, output power".
- [5] IEC 244-2: "Bandwidth, out of band power and power of non-essential oscillations".
- [6] EN 60244-13: "Methods of measurements for radio transmitters, Performance characteristics for FM sound broadcasting".
- [7] CCIR Recommendation 468-4 (1986): "Measurement of audio frequency noise voltage levels in sound broadcasting".
- [8] ETR 132: "Code of practice for site engineering of VHF, frequency modulated, sound broadcasting transmitters".

3 Definitions and abbreviation

3.1 Definitions

For the purposes of this ETS the following definitions apply:

out-of-band emissions: Emission on a frequency or frequencies immediately outside the necessary bandwidth which results from the modulation process, but excluding spurious emissions.

spurious emissions: Emission on a frequency or frequencies which are outside the necessary bandwidth and the level of which may be reduced without affecting the corresponding transmission of information. Spurious emissions include harmonic emissions, parasitic emissions, intermodulation products and frequency conversion products but exclude out of band emissions.

unwanted emissions: Consist of spurious emissions and out of band emissions.

signal L: Signal L corresponds to the information in the left channel.

signal R: Signal R corresponds to the information in the right channel.

sum signal M: $M=(L+R)/2$; this information is also the signal for the monophonic receiver.

difference signal S: $S=(L-R)/2$; this information allows the stereo-receiver to regain signals L and R in conjunction with the M signal.

Multiplex (MPX) signal: This signal contains all information, including the pilot tone and any supplementary signal which is used to frequency modulate the VHF FM transmitter.

stereo subcarrier: The subcarrier (38 kHz) converts the S signal to the carrier-frequency position (23 kHz - 53 kHz).

pilot tone: The pilot tone (19 kHz) is used to regain the stereo subcarrier in the stereo-receiver.

Radio Data System (RDS): RDS is a signal containing information on programmes and broadcasting network as defined in EN 50067 [2]. This signal is carried by a subcarrier at 57 kHz, amplitude modulated by the encoded data with suppressed carrier in a frequency band of $\pm 2,4$ kHz.

supplementary signal: This signal can operate in the range between 53 kHz and 76 kHz, according to CCIR Recommendation 450-1 [1].

3.2 Abbreviations

For the purposes of this ETS, the following abbreviations apply:

AF	Audio Frequency
AM	Amplitude Modulation
EMC	Electro Magnetic Compatibility
FM	Frequency Modulation
ISS	Interfering Signal Source
MPX	Multiplex
RDS	Radio Data System
RF	Radio Frequency
rms	root mean square
S/N	Signal to Noise
TUT	Transmitter Under Test
VHF	Very High Frequency

4 Technical requirements

The transmitter shall be tested:

- at its rated output power, as declared by the manufacturer;
- into a load as defined in subclause 4.13 a), unless otherwise stated.

The transmitter operating at any frequency in the range 87,5 MHz to 108 MHz shall comply with the requirements of this clause.

If the transmitter incorporates RDS, then the transmission shall be in accordance with CCIR Recommendation 450-1 [1] and EN 50067 [2]. If the transmitter incorporates any other form of supplementary signal(s), then the transmission shall be in accordance with CCIR Recommendation 450-1 [1].

The method of measurement for the parameters listed in the following subclauses shall be in accordance with EN 60244-13 [6], IEC 244-1 [4] and IEC 244-2 [5], unless otherwise stated.

4.1 Characteristics of RF interface ports

All RF output ports designated to interface with other equipment shall operate into a nominal impedance of 50 Ω .

All RF input ports designated to interface with other equipment shall have a nominal impedance of 50 Ω when driven in accordance with the manufacturers specifications.

4.2 Transmitter input configuration

If the transmitter does not incorporate a stereo encoder and is intended for stereo operation then a test encoder to the specification given in annex A shall be used.

If the transmitter is designed only for monophonic transmissions (i.e. without an MPX input) out-of-band emissions shall be tested in accordance with subclause 4.11.3.

4.3 Transmitter output characteristics

The carrier output power shall be within $\pm 1,0$ dB of the rated output power under normal operating conditions as defined in subclause 5.1. The carrier output power under extreme conditions, as defined in subclause 5.2, shall be within +2,0 dB and -3,0 dB of the rated output power.

The transmitter shall be capable of delivering its rated RF output power into an antenna with an input return loss of ≥ 16 dB at all phase angles.

The transmitter shall be capable of operating without damage into loads including open and short circuits, and may shut down or operate at reduced RF output power level to meet this requirement.

The reverse intermodulation performance at the operating frequency or frequencies of the transmitter shall be measured according to the method described in annex D. The frequency offset of the interfering source shall be varied over the range 300 kHz to 20 MHz maximum on both sides of the carrier, but shall remain within the range 87,5 MHz to 108 MHz.

The reverse intermodulation shall not exceed -10 dB at all frequency offsets within the above range.

4.4 Frequency range

The transmitter shall operate within the range 87,5 MHz to 108 MHz. The preferred operating frequencies shall be multiples of 100 kHz. If 100 kHz channel spacing is not used the actual channel spacing shall be declared by the manufacturer.

4.5 Frequency stability

"Frequency error" and "frequency drift" are defined in IEC 244-1 [4], sections 5.2.5 and 5.2.6 respectively.

4.5.1 Frequency error

The carrier frequency shall be maintained within ± 2 kHz of its nominal value, under normal and extreme operating conditions as defined in clause 5.

4.5.2 Frequency drift

The stability of the carrier frequency shall be better than ± 300 Hz within a three month period when measured under identical operating conditions at the start and end of the period.

4.6 Frequency adjustment

The carrier frequency shall be adjustable to an accuracy of ± 50 Hz.

4.7 Unwanted frequency shift

This subclause applies to transmitters incorporating frequency control loops.

To prevent unwanted frequency shift, the transmitter shall incorporate the means by which the RF output is automatically muted if the carrier frequency generation circuits develop a fault which would result in a loss of frequency control.

In the case of a carrier frequency change, the RF output shall be muted during the tuning process.

The muting suppression shall be at least 50 dB, or the output power shall be reduced to ≤ 1 mW, whichever value results in the lowest emission.

4.8 Frequency deviation

Notwithstanding subclauses 4.9 and 4.10 below, the maximum peak frequency-deviation of the installed transmitter system, including limiting equipment which may be external to the transmitter (see note) shall not exceed ± 75 kHz under normal operating conditions as specified in clause 5. Also the parameters specified in section 2.3 of CCIR Recommendation 412-5 [3] and section 2.2 of CCIR Recommendation 450-1 [1] shall be fulfilled.

NOTE: For further information see ETR 132 [8].

4.9 Overdeviation

This subclause verifies that any non linearities in the transmitter do not cause excessive out-of-band emissions when the transmitter is subjected to abnormal Audio Frequency (AF) input levels. Under these conditions it is possible that the RF spectrum will be unacceptably polluted, even though the deviation may not exceed ± 75 kHz.

The test conditions shall be as follows:

- a) the transmitter shall be modulated with a sinusoidal input tone. The input level shall be adjusted to obtain a frequency deviation of ± 32 kHz for monophonic transmissions, and to ± 40 kHz for stereophonic transmissions including pilot tone;
- b) the output level of the AF generator shall be increased by 12 dB. The resulting transmitter RF output spectrum shall not exceed the levels shown in figure 4 when measured using a 1 kHz resolution bandwidth.

The measuring procedures are given in annex B.

4.10 Deviation sensitivity stability

The deviation sensitivity (MHz/volt) of the transmitter shall remain within $\pm 3\%$ of the manufacturer's declared value over the range of normal and extreme operating conditions specified in clause 5.

However for frequency-agile transmitters intended for operation under remote or automatic frequency control (e.g. "N+1" systems), and operating on any frequency within the range 87,5 MHz to 108 MHz, the deviation sensitivity (MHz/volt) of the transmitter shall remain within $\pm 5\%$ of the manufacturer's declared value.

4.11 Unwanted emissions

The following requirements shall be met when operating into the relevant test loads as defined in subclause 4.13 and as applied in accordance with table 1.

4.11.1 Spurious emissions

Spurious emissions shall not exceed:

- a) the limits set out in figure 1 in the frequency range 87,5 MHz to 137 MHz;
- b) the limits set out in figure 2 at any other frequency in the range 30 MHz to 1 GHz.

4.11.2 Out-of-band emissions - stereophonic transmitters

The measurements for out-of-band emissions shall be carried out in accordance with EN 60244-13 [6], using procedures specified for stereophonic operation.

The effective value of the out-of-band emission shall not exceed the values shown in figure 3.

4.11.3 Out-of-band emissions - monophonic transmitters

This test shall be applied to transmitters without an MPX input. The measurements shall be carried out in accordance with EN 60244-13 [6] using the procedures specified for monophonic operation.

The effective value of the out-of-band emission shall not exceed the values shown in figure 3.

4.12 Amplitude Modulation (AM)

4.12.1 Synchronous AM (AM due to FM)

The permitted level of AM due to FM shall not exceed 2% for a peak deviation of ± 40 kHz at a modulation frequency of 500 Hz. The measurement shall be carried out in accordance with EN 60244-13 [6], section 8.3.2.

4.12.2 Hum and noise (residual AM)

The permitted level of residual AM in the absence of modulation shall not exceed 1% when measured in a bandwidth of 20 Hz to 20 kHz (unweighted). The measurement shall be carried out in accordance with EN 60244-13 [6], section 8.3.1.

4.13 Test load characteristics

For measurements detailed in table 1, the transmitter shall be required to operate into:

- a) a precision load with a return loss of ≥ 26 dB in frequency range 87,5 MHz to 108 MHz and ≥ 16 dB at all other frequencies up to 1 000 MHz;
- b) a narrow band load with band pass characteristics as follows:
 - return loss ≥ 26 dB over the range $f_c \pm 100$ kHz;
 - return loss $\leq 0,5$ dB outside the range $f_c \pm 1$ MHz;

where f_c = transmitter carrier frequency;

- c) a load with return loss of (16 ± 1) dB over the range $f_c \pm 500$ kHz for all phase angles.

NOTE: This phase requirement can be met in practice by changing the phase of the reflection in steps of 90° .

Table 1: Test applicability table

Measurement Types of load	subclause 4.11.1 spurious emissions	subclause 4.11.2 and subclause 4.11.3 out of band emissions
load a)	test	test
load b)	test	no test
load c)	test	test

5 Operating and test conditions

The requirements in this ETS shall be met with the transmitter operated at any point within the normal ranges described in subclause 5.1. Tests need only be carried out on certain parameters where indicated in clause 4 at the two extremes of these ranges.

The requirements in this ETS shall be met with the transmitter operated at any point within the extreme ranges described in subclause 5.2. Tests need only be carried out on certain parameters where indicated in clause 4 at the two extremes of these ranges.

5.1 Normal operating and test conditions

- ambient temperature: 15°C to 30°C;
- mains voltage: Voltage: $U_0 + 6\%$ to -10%
 Frequency: 49 Hz to 51 Hz
 Distortion: $\leq 10\%$

where U_0 is the nominal single or three phase supply voltage, as declared by the manufacturer;

- altitude: $\leq 3\,000$ metres above sea level;
- warm-up period: 20 minutes, except 1 hour for frequency stability;
- humidity: $\leq 90\%$ RH non condensing with the transmitter at a higher temperature than the ambient temperature.

5.2 Extreme operating and test conditions

- ambient temperature: 0°C to 40°C;
- mains voltage: $U_0 + 6\%$ to -10% ;

where U_0 is the nominal single or three phase supply voltage.

Outside these operating conditions additional requirements may be needed to ensure compliance with this ETS. Annex C gives some guidance on the range of conditions which may be found throughout Europe.

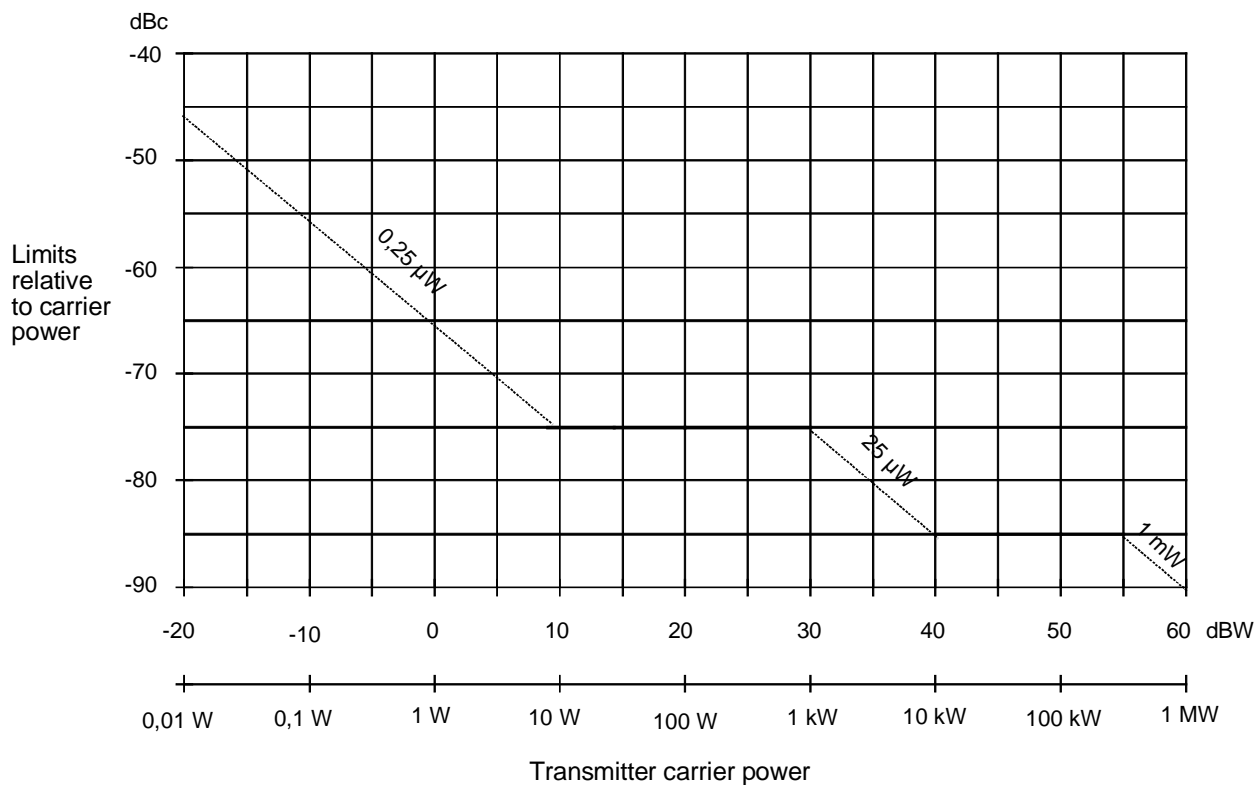

Figure 1: Limits for spurious emission within the frequency range 87,5 to 137 MHz

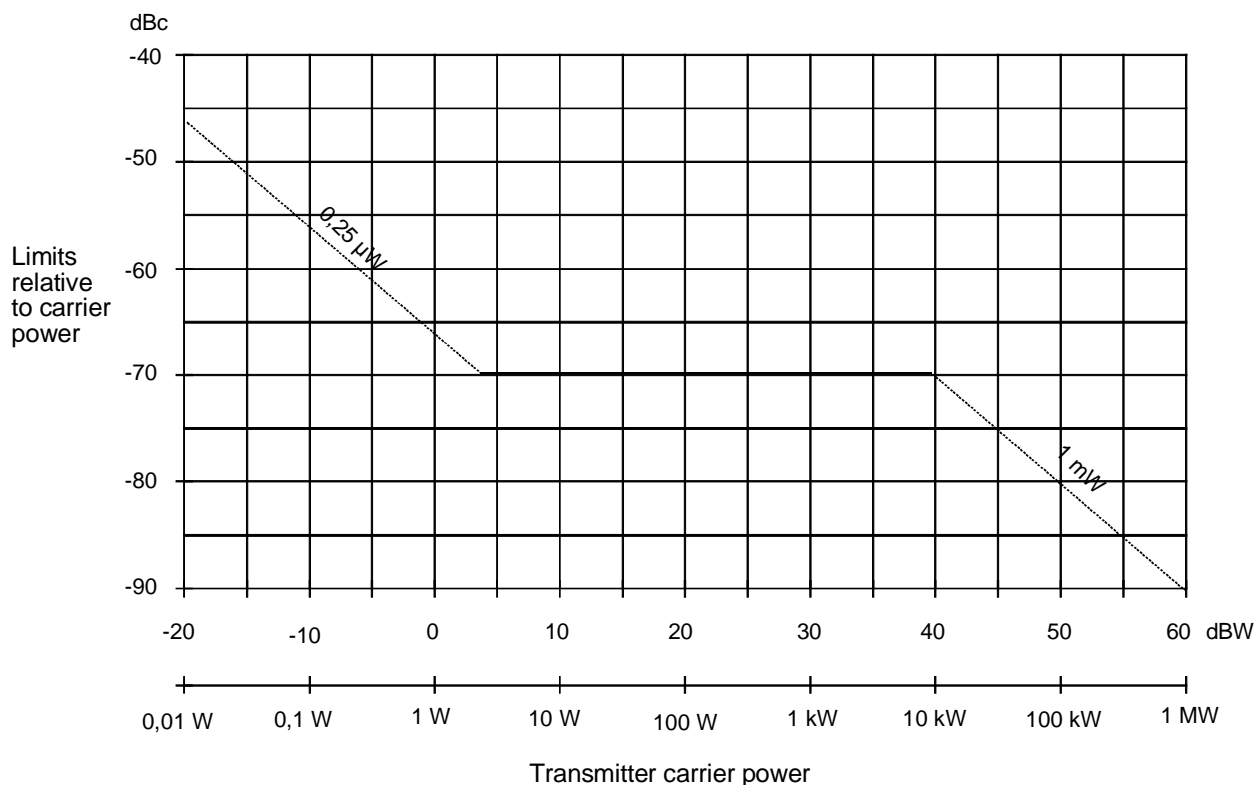
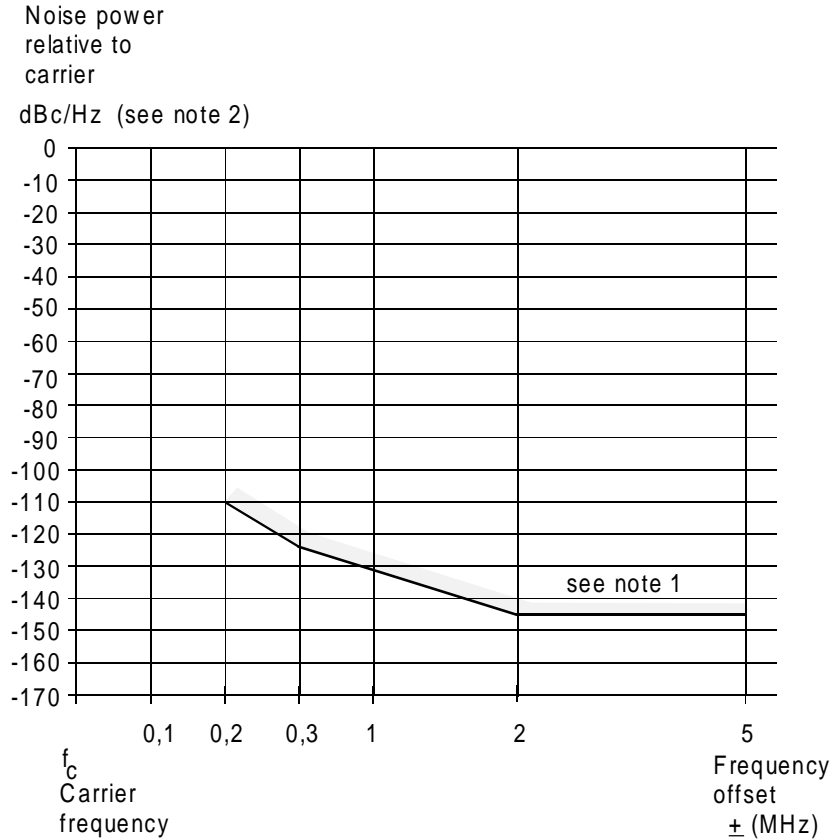

Figure 2: Limits for all spurious emissions in the frequency ranges 30 MHz to 87,5 MHz and 137 MHz to 1 GHz



- NOTE 1: The far-out of band emissions are influenced by transmitter output filter/combiner networks. Measurements should be made with these in place, where necessary.
- NOTE 2: The measurement bandwidth is 1 kHz; this curve is obtained by subtracting 30 dB from the measured values.
- NOTE 3: Under certain circumstances, arising at a small minority of sites, this curve may not guarantee full compatibility with other services and a more stringent specification may be required (see ETR 132 [8] for further information).

Figure 3: Limits for out-of-band emissions (see subclause 4.11)

Power relative
to carrier
dBc/kHz

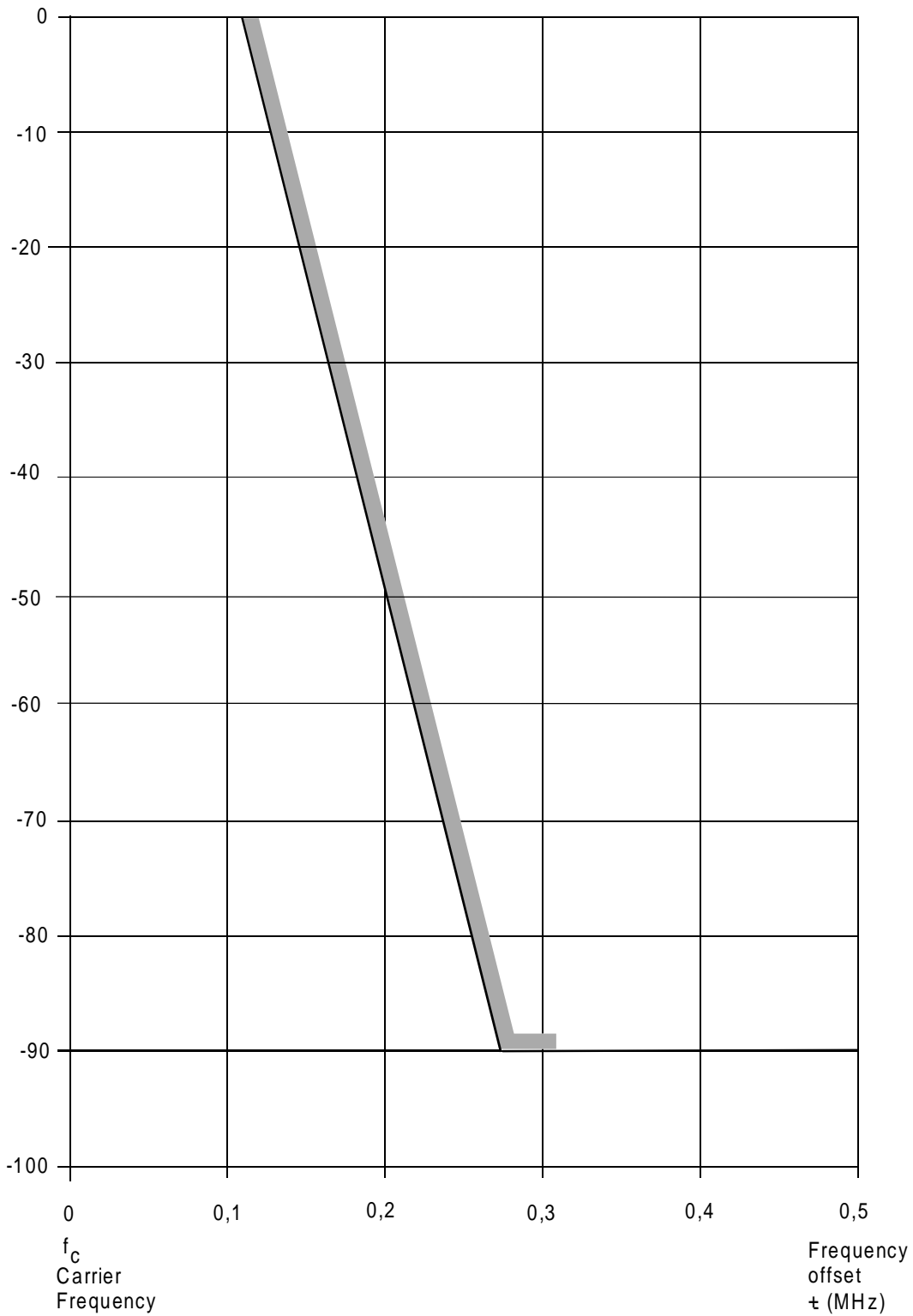

Figure 4: Limits on transmitter spectrum due to abnormal AF input levels (see subclause 4.9)

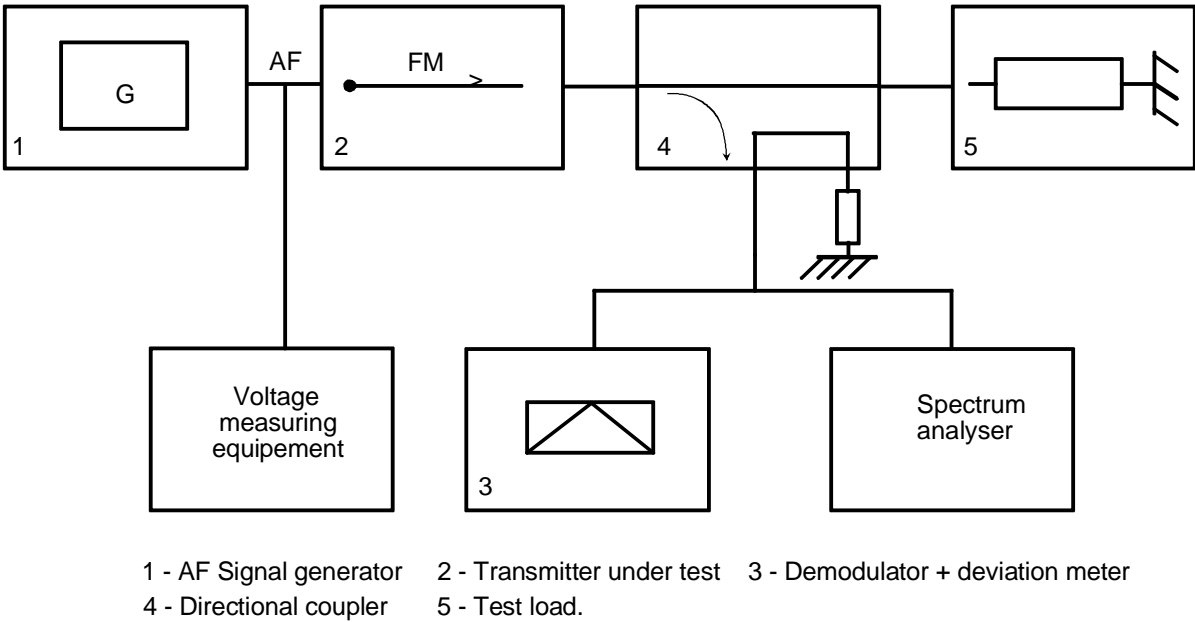

Figure 5: Measuring arrangements for monophonic transmitters abnormal input levels (see subclause 4.9)

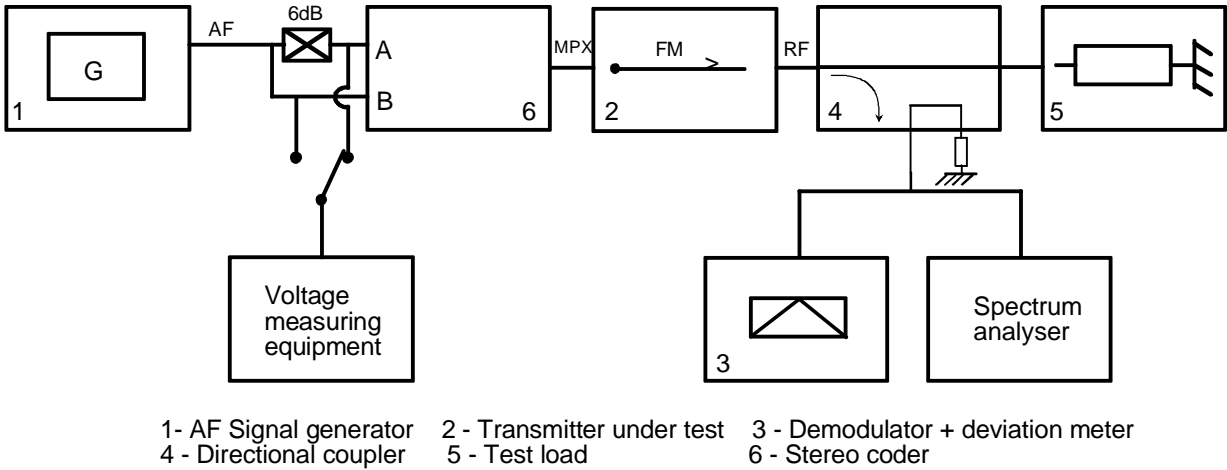

Figure 6: Measuring arrangements for stereophonic transmitters

Annex A (normative): Stereo test encoder for pilot tone system, audio and multiplex parameters

A.1 Introduction

This annex covers the essential requirements of test encoders for VHF FM sound broadcasting transmitters in the band 87,5 MHz to 108 MHz, and modulated in accordance with CCIR Recommendation 450-1 [1] pilot tone system.

A.2 Input parameters

Apart from the two AF inputs (L and R) the encoders may comprise one or more inputs for additional signals such as RDS and or auxiliary channels and signals.

A.2.1 Audio inputs

It is recommended that the AF input impedance shall be ≥ 2 k Ω balanced in the whole AF range (40 Hz to 15 kHz).

Full output level as defined in subclause A.4.2 should be achievable with input signal between 0 dBm and +12 dBm where L = R (in phase) at a frequency of 400 Hz.

Input sensitivity shall be adjustable by means of a single or two separate controls and or a balance control which permits adjustments of the output level with any input signal in the range allowed, with a precision of at least $\pm 0,15$ dB and a gain difference between channels not greater than 0,1 dB.

Both input AF channels shall be provided with a pre-emphasis network, with a time constant of (50 ± 1) microseconds in accordance with CCIR Recommendation 450-1 [1]. For testing purposes, a facility shall be provided to switch off the pre-emphasis.

Both AF channels shall be equipped with a 15 kHz low-pass filter. The attenuation of these filters shall be at least 40 dB at 19 kHz, referred to 15 kHz. The stop-band attenuation above 19 kHz shall be ≥ 30 dB.

A.2.2 Auxiliary inputs

A.2.2.1 Impedance

If an auxiliary input is provided its impedance should be ≥ 2 k Ω unbalanced in the range 53 kHz to 75 kHz.

A.2.2.2 Gain

If one or more auxiliary inputs are present, their input to output gain shall be adjustable (15% of full output voltage is usually enough) to produce the required output in the required frequency band.

A.3 Pilot signal

A.3.1 Pilot tone

The pilot tone shall be in accordance with section 2.2.2 of CCIR Recommendation 450-1 [1].

A.3.2 Pilot tone output

If a pilot tone output is provided, the peak to peak output voltage shall be $(1 \pm 0,2)$ Volt into a load of ≥ 1 k Ω . The output shall be a.c. coupled square wave with a duty cycle of 50%.

A.3.3 External pilot synchronising

If an external pilot synchronising input facility is provided the peak to peak synchronising signal shall be in the range 0,8 V to 1,2 V into a load of $\geq 1 \text{ k}\Omega$.

A.4 Output

A.4.1 MPX coded signal

At least one MPX coded signal output shall be provided. This output shall not contain any DC offset.

A.4.2 Level of the MPX coded signal

The output level of the MPX coded signal for full deviation of a transmitter (i.e. $\pm 75 \text{ kHz}$) shall be adjustable in the range required. The stereo encoder shall be capable of delivering its full performance as defined in this annex, into the following loads:

- a) $\geq 300 \Omega$ parallel with max capacitance of 5 000 pF;
- b) 75Ω resistive load.

The pilot tone level shall be adjustable within the range from 8% to 10% of the output level.

A.4.3 Spurious frequencies

At the reference output level for full modulation with $L = R$ or $L = -R$, the sub-carrier level and the level of all spurious frequencies higher than 53 kHz shall be in accordance with table A.1.

Table A.1

Frequency	Level
38 kHz (stereo sub-carrier)	$\leq -42 \text{ dBr}$
53 kHz to 55 kHz	$\leq -45 \text{ dBr}$
55 kHz to 59 kHz	$\leq -57 \text{ dBr}$
59 kHz to 200 kHz	$\leq -65 \text{ dBr}$
200 kHz to 1 MHz	$\leq -70 \text{ dBr}$

The requirements in table A.1 shall be met for any combination of audio inputs in the range 40 Hz to 15 kHz, which produce 0 dBr MPX output level. No supplementary signals shall be present.

NOTE: Usually the worst condition is approached with $L = -R$ at maximum allowable level: in this case an applied signal with a frequency f_{si} will produce two spectral lines at $38 \text{ kHz} \pm f_{si}$ whose reference level is -7 dBr whilst the pilot tone at 19 kHz is -21 dBr.

A.5 Non linear distortion

This measurement is performed at the MPX output via a suitable quality test decoder on both AF decoded channels. During this test pre-emphasis and de-emphasis shall be switched off.

A.5.1 Harmonic distortion of the encoder

The harmonic distortion of the encoder shall be $\leq 0,5\%$ for full deviation when modulated with an AF input signal in the range 40 Hz to 15 kHz.

For an increase of the input signal of 2,5 dB the harmonic distortion shall be $\leq 1\%$.

A.5.2 Base-band frequency intermodulation products of the encoder

The base-band frequency intermodulation products d_2 and d_3 of the encoder shall not exceed 0,25% and 0,37% respectively, when fully modulated with a two tone composite signal of the same amplitude and with a frequency difference of 1 kHz, in the range 5 kHz to 15 kHz.

For an increase in the composite input signal of 2,5 dB, the intermodulation products shall be $\leq 0,5\%$ and $\leq 0,75\%$ respectively.

A.5.3 Distortion products of the decoder

The root mean square (rms) sum of all distortion products measured at the output of the decoder on channel R, caused by non-linear crosstalk, shall not exceed 0,5% when channel L is fully modulated with a single tone in the frequency range 40 Hz to 15 kHz.

The above procedure shall be repeated with channels L and R interchanged.

Similarly with a 2,5 dB increase in the input level the corresponding cross talk shall be $\leq 1\%$.

A.6 Signal to Noise ratio (S/N)

The S/N ratio shall be measured via a suitable test decoder connected to the MPX output (with a quasi-peak detector as per CCIR Recommendation 468-4 [7] with pre-emphasis and de-emphasis in) on both AF decoded outputs and related to full output level (0 dBr) at 400 Hz.

A.6.1 Unweighted S/N

Unweighted S/N shall be ≥ 72 dB.

A.6.2 Weighted S/N

Weighted S/N according to the CCIR Recommendation 468-4 [7] shall be ≥ 72 dB.

A.7 Linear distortion

This clause is advisory only, because linear distortion has no effect on spectrum occupancy.

A.7.1 AF channel amplitude difference

The amplitude difference measured on each AF channel decoded by a test decoder should not exceed 1 dB related to 400 Hz in the frequency range 40 Hz to 15 kHz (pre-emphasis is switched off).

A.7.2 Auxiliary input

If an auxiliary input is present, the related frequency response at the MPX output should not vary more than $\pm 0,5$ dB related to 57 kHz in the range 53 kHz to 75 kHz.

A.8 Linear crosstalk

This clause is advisory only, because linear crosstalk has no effect on spectrum occupancy.

A.8.1 Crosstalk attenuation between the M and S channels

Crosstalk attenuation between the M and S channels should be ≥ 38 dB in both directions, i.e. measured with both input L and R channels driven in phase or in antiphase.

A.8.2 Crosstalk attenuation between the two AF channels

Crosstalk attenuation between the two AF channels should be ≥ 46 dB in the range 100 Hz to 5 kHz. Below 100 Hz and above 5 kHz the crosstalk attenuation is allowed to decrease by 6 dB per octave.

Annex B (normative): RF Spectrum measurements to detect excessive spectrum pollution due to abnormal AF - input levels

B.1 Measuring arrangement

For monophonic operation the arrangement of figure 5 applies.

For stereophonic operation the arrangement of figure 6 is applies.

Both channels L and R shall be fed simultaneously with an AF signal in the ratio $L = R - 6\text{dB}$ (channel L with half the amplitude of channel R).

A second output from a directional coupler is connected to an RF spectrum analyzer.

B.2 Measuring procedure

For monophonic operation:

- 1) switch the analyser to a bandwidth of 1 kHz;
- 2) adjust the spectrum analyser with the unmodulated FM carrier at the input to 0 dB;
- 3) modulate the transmitter with an AF signal;
- 4) adjust the output of the AF generator at 1 kHz to a level which corresponds to a frequency deviation of ± 32 kHz i.e. 7,4 dB below maximum deviation;
- 5) increase the output level of the AF generator by 12 dB, resulting in a frequency deviation of approximately ± 128 kHz for transmitters without a limiter;
- 6) tune the analyser to frequencies in the range $f_c \pm \Delta f$ where $100 \text{ kHz} \leq \Delta f \leq 500 \text{ kHz}$.

For stereophonic operation:

- adjust the output of the AF generator at 1 kHz to a level corresponding to a frequency deviation of ± 40 kHz including the pilot tone;
- for the remaining procedure, see the method used for monophonic operation.

NOTE: It may be necessary to use a notch filter at the nominal transmitter frequency in order to achieve the required dynamic range. The resulting spectrum should be corrected to compensate for the response to any notch filter outside the range $f_c \pm 100$ kHz.

B.3 Presentation of the results

The results shall be presented in the form of a graph in which relative levels in decibels are given as a function of the frequency displacement from the carrier.

Annex C (informative): General conditions of operation

This annex gives some guidance on the range of conditions which may be found throughout Europe.

C.1 Temperature in the operating room

1°C to 45°C.

C.2 Relative humidity in the operating room

Up to 90% (maximum temperature 26°C).

C.3 Cooling air temperature

1) Entering the cooling system:

- -25°C to +40°C.

2) Entering the transmitter:

- -20°C to +45°C.

C.4 Relative humidity of the air entering the cooling system up to 25°C

Up to 95%.

C.5 Air pressure

720 to 1 060 hPa.

C.6 Immunity against mechanical vibrations airborne or air pressure

Up to 100 dB (related to 2×10^{-5} Pa).

C.7 Immunity against electric field strength within the broadcasting bands

Up to 10 V/m (VHF and UHF bands).

Up to 100 V/m (LF, MF and HF bands).

See ETS 300 447 (bibliography).

C.8 Immunity against magnetic field strength

Up to 0,5 A/m (LF, MF and HF bands).

C.9 Mains voltage

Sudden change of $\pm 10\%$ of nominal value.

C.10 Mains frequency

$\pm 5\%$.

Annex D (normative): Reverse intermodulation measurements

D.1 Scope of annex

This annex covers the method of measurement of reverse intermodulation on the output of VHF FM sound broadcasting transmitters in the band 87,5 MHz to 108 MHz, when external RF signals coming from other transmitters are coupled to their output port, due to leakage in combining systems or reception via the antenna.

D.2 Measurement arrangement

The two alternative arrangements are shown in figure D.1.

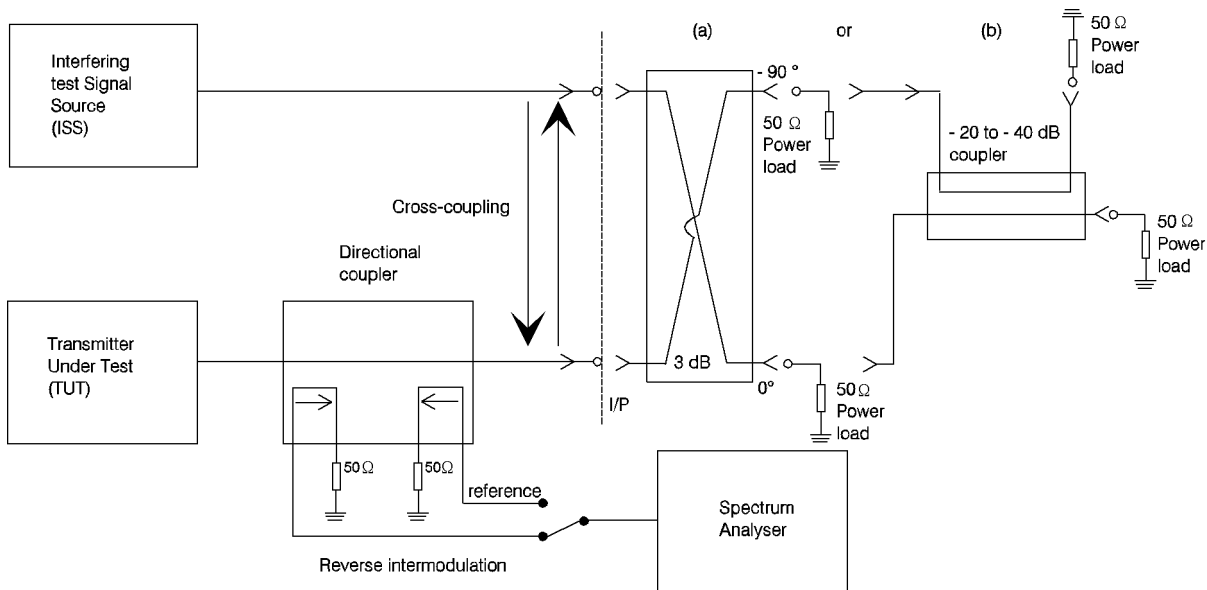

Figure D.1: Reverse intermodulation measuring arrangement

A distinct advantage of the method laid down is its inherent simplicity using standard equipment usually present in any RF transmission laboratory.

D.3 Principle of measurement

The test relies on either:

- the finite isolation between the nominally isolated ports of a -3 dB coupler, whose output ports are terminated into matched loads of adequate power handling capability. When used in this way, good quality couplers exhibit a typical -30 dB to -40 dB coupling between input ports; or
- the coupling inherent in a backward-wave directional coupler with a coupling co-efficient in the range -20 dB to -40 dB.

The power of the Interfering Signal Source (ISS) in figure D.1, is coupled to the output of the Transmitter Under Test (TUT) producing an intermodulation product, whose level depends on the linearity and the frequency response of the output stage of the TUT. The frequency of the most significant intermodulation product is given by:

$$f_{\text{int}} = 2 \times f_{\text{TUT}} - f_{\text{ISS}}$$

where f_{int} = frequency of the intermodulation product (MHz);
 f_{TUT} = carrier frequency of the TUT (MHz);
 f_{ISS} = frequency of the ISS (MHz).

While a precise coupling is not easily determinable, this method achieves a convenient level of coupled signal, provided the two sources are not very different in power (in practice 1:1 to 10:1 is usually adequate) and within the dynamic range of the spectrum analyser.

For a power ratio between the TUT signal, as measured on the "reverse intermodulation" port, and the ISS signal, as measured on the "reference" port within a range of 20 dB to 50 dB, it may be assumed that the mixing action is sufficiently linear, and the measurement of the reverse intermodulation figure is unaffected. The measurement shall be effected with a ratio as near as possible to 30 dB between TUT and ISS signals at these ports.

A suitable interfering source may be another transmitter whose power is similar to the TUT and its frequency readily changeable. The reverse intermodulation characteristic of the ISS is not especially important, because the spurious signal which results is very low in respect to the main interfering signal and greatly attenuated; being coupled to the TUT by the measuring arrangement.

The interfering signal level at the TUT is different when the incident and the reflected signals are compared. The intermodulation signal which results is mainly directed towards the coupler.

The reverse intermodulation figure is the ratio in dB between the incident interfering signal power, as measured on the "reference" port, and the resulting intermodulation signal, as measured on the "reverse intermodulation" port, without changing the sensitivity of the spectrum analyser. A directional coupler is needed whose two output ports have the same sensitivity.

D.4 Measurement routine

The measurement shall be carried out at 3 different frequency settings (f_{TUT}) of the TUT:

- a) 87,5 MHz;
- b) 98 MHz;
- c) 108 MHz.

For each setting the frequency of the ISS shall be varied in the range 87,5 MHz to 108 MHz except the range $f_{\text{TUT}} - 300$ kHz to $f_{\text{TUT}} + 300$ kHz. The results shall be shown either as a graph or the worst value shall be recorded.

During the test, neither the TUT or the ISS shall be modulated.

Annex E (informative): Bibliography

- 1) ETSI ETR 027 (1991): "Methods of measurement for private mobile radio equipment".
- 2) Technical Standard Specifications of the Public Broadcasting Organisations in the Federal Republic of Germany No 5/3.2 concerning Stereo Coder for the Pilot Tone System. Publisher: Institut für Rundfunktechnik GmbH, rev. July 1985.
- 3) ETS 300 447: "Radio Equipment and Systems; EMC standard for VHF FM sound broadcasting transmitters".

History

Document history	
January 1995	First Edition
January 1996	Converted into Adobe Acrobat Portable Document Format (PDF)